



# Installing Enphase 600A Consumption CTs















Use this instruction with the *Enphase IQ8D Commercial Gateway Quick Install Guide* to install Enphase consumption monitoring Current Transformers (CTs). The Enphase IQ8D Commercial Gateway uses a set of three 600A split core CTs for monitoring consumption. They perform metering with an accuracy class of 1%. Rated at Pollution Degree 3, you can use the CT inside electrical equipment in residential or in harsh, industrial conditions. Read and follow all warnings and instructions in this instruction and in the Quick Install Guide included with your Gateway and available at [enphase.com/support](http://enphase.com/support).

## SAFETY

### SAFETY AND ADVISORY SYMBOLS

	<b>DANGER:</b> This indicates a hazardous situation, which if not avoided, will result in death or serious injury.
	<b>NOTE:</b> This indicates information particularly important for optimal system operation. Follow instructions carefully.

### SAFETY INSTRUCTIONS

	<b>DANGER:</b> To reduce the risk of electric shock, always open or disconnect circuit from power-distribution system (or service) of building before installing or servicing current transformers.
	<b>DANGER:</b> Risk of electrocution! Do not install CTs when current flowing in the sensed circuit. Always install CT wires in the terminal blocks before energizing the sensed circuit.
	<b>DANGER:</b> If equipment is used in a manner not specified by Enphase Energy, the protection provided by the equipment may be impaired.
	<b>DANGER:</b> Risk of electric shock. Be aware that installation of this equipment includes risk of electric shock. If you wire the IQ Gateway the main load center before beginning wiring. If the subpanel cannot be de-energized, a qualified electrician may safely install the CTs as directed, making sure to connect the leads and then place the CTs around each wire and latch.
	<b>DANGER:</b> Risk of electric shock. Risk of fire. Only qualified personnel should troubleshoot, install, or replace the CTs.
	<b>NOTE:</b> Because of variance in switchboard design and main power feed, there may not always be enough space to install CTs.
	<b>NOTE:</b> Do not install the CTs in a switchboard where they exceed 75% of the wiring space of any cross-sectional area within the equipment.
	<b>NOTE:</b> Perform all electrical installations in accordance with all national and local electrical codes.
	<b>NOTE:</b> Restrict installation of current transformers in an area where they would block ventilation openings, or in area of breaker arc venting.
	<b>NOTE:</b> Not suitable for Class 2 wiring methods and not intended for connection to Class 2 equipment.
	<b>NOTE:</b> Secure current transformer and route conductors so that they do not directly contact live terminals or bus.
	<b>NOTE:</b> When wiring the IQ Gateway for production and consumption metering, be sure to install the current transformers (CTs) exactly as described for your application.
	<b>NOTE:</b> When installing CTs, it is important to match CT and sense voltage phases. Be sure to consistently identify the two AC lines at three points: the main load center feed, the Gateway, and the solar production circuit breaker. Wire colors (typically black and red) may not always consistently identify L1 and L2. If in doubt, use a multimeter to check.
	<b>NOTE:</b> Only run active conductors through the CT. The CT can monitor multiple active conductors. You may run more than one wire through the CT if all wires are on the same phase and they fit the opening in the CT.
	<b>NOTE:</b> For indoor use only.

### SPECIFICATIONS

SPECIFICATION	CT-600-SPLIT
CT type	Split core
CT accuracy (error rate)	<1.5%
Max primary supported current	600A
Turns ratio	4800
Pollution degree	3
Dimensions	3.68inch * 4.4inch * 0.98inch
Aperture	1.97inch * 1.97inch
Supported Cable Size	Up to a maximum size of 300KCMIL conductors
Primary voltage (range)	250VAC max
Frequency	50-60Hz
Operating temperature	-40 to 85 degree C
Humidity	95%
Pollution degree	3
Compliance	UL2808 certified with service entrance rating, ROHS(latest version)

### INSTALLATION

For more information, see the reverse of this document for tips. Refer also to the *IQ8D Commercial Gateway Quick Install Guide*.

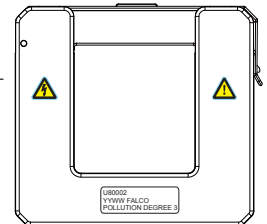

#### Preparation

- A) If not already done, de-energize the home load panel and the PV system.

#### Remove any pre-installed consumption CTs

- A) Remove the line 1, line 2 and line 3 conductors circuit to which the consumption CTs are connected.
- B) Remove the existing CTs.

#### Install the consumption CTs

- A) Refer to the diagram on the reverse of this document for wiring.
- B) Install the **consumption** CTs on active phases as required:
  - Locate the arrow on the CT label.
  - Make sure that the AC mains wire(s) are de-energized until you have secured the CT wires in the terminal blocks.
  - To monitor consumption on Line 1:**
    - Connect the white wire to the white "C1" and the blue wire to the blue "C1" terminal.
    - Clamp the CT on the main supply Line 1. When the consumption CT is on Line 1 conductor, the arrow must point toward the load (away from the grid).
  - **To monitor consumption on Line 2:**
    - Connect the white wire to the white "C2" terminal and the blue wire to the blue "C2" terminal.
    - Clamp the CT on the main supply Line 2. When the consumption CT is on Line 2 conductor, the arrow must point toward the load (away from the grid).
  - **To monitor consumption on Line 3:**
    - Connect the white wire to the white "C3" terminal and the blue wire to the blue "C3" terminal.
    - Clamp the CT on the main supply Line 3. When the consumption CT is on Line 3 conductor, the arrow must point toward the load (away from the grid).
  - **Tighten all connections to 5 in-lbs (0.6 N m).**
- C) Close and secure the terminal block door of the Gateway.
- D) Turn on the PV system.

**IQ8D Commercial Gateway Terminal Block**

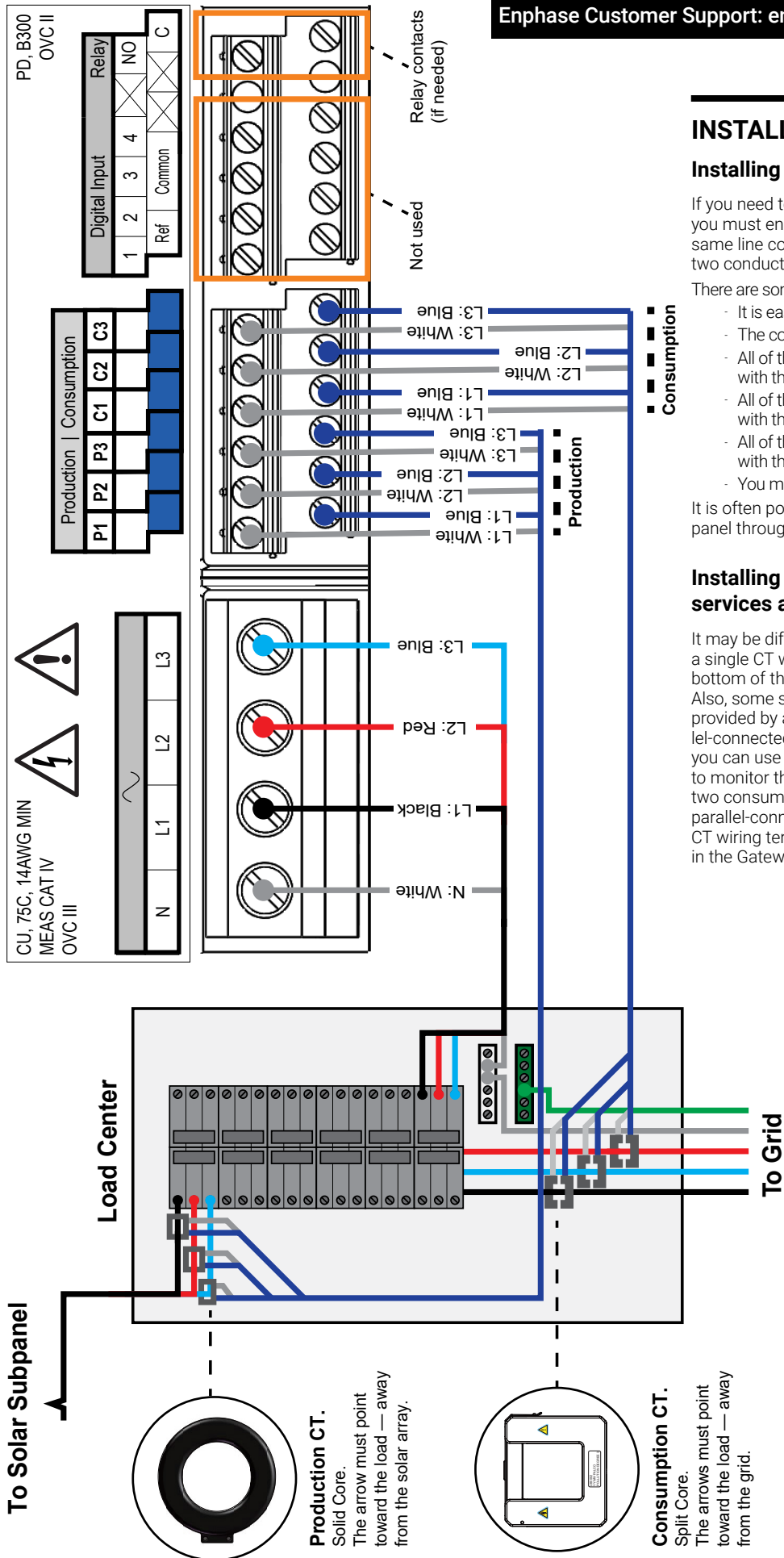

**INSTALLATION TIPS**

**Installing multiple conductors in a single CT**

If you need to install multiple conductors in a single CT, you must ensure that the conductors terminate on the same line conductor, so the voltage at the terminals of the two conductors will be 0V between them.

There are some challenges to this approach:

- It is easy to make a wiring error.
- The conductors must fit within the CT.
- All of the conductors on line 1 must be bundled and with the loads on the line 1 CT.
- All of the conductors on line 2 must be bundled and with the loads on the line 2 CT.
- All of the conductors on line 3 must be bundled and with the loads on the line 3 CT.
- You may need to extend some of the circuits.

It is often possible to run all of the conductors in a service panel through a single set of consumption CTs.

**Installing parallel-connected CTs for 1200A services and in crowded service panels**

It may be difficult to install multiple conductors through a single CT when some of the conductors enter from the bottom of the service panel and others enter from the top. Also, some service panels have 1200A services that are provided by a set of two 600A conductors and parallel-connected 600A circuit breakers. In those scenarios, you can use a set of parallel-connected consumption CTs to monitor the home's consumption. Do this by installing two consumption CTs on each line conductor and then parallel-connecting the output conductors at the Gateway CT wiring terminals or in a wire connector prior to landing in the Gateway terminals.

