

Design Considerations for Running Pumps and HVAC in Off grid with Encharge Energy Storage

Summary

1. When most HVAC units and electric motors and pumps are turned on, they draw 4-8 times of their normal operating current for a short duration. This makes supporting the startup of HVACs and pumps challenging when they are operating off-grid.
2. The Enphase proprietary technology known as Power Start™ can significantly reduce the power needed to startup pumps and HVAC's when they are off-grid.
3. Enphase recommends that a soft starter is installed on HVAC units for off-grid operation, as it can reduce the current needed to startup the equipment by 35%.
4. We suggest Hyper Engineering SureStart soft starters to be installed for AC units. Please see <http://www.hypereng.com> for more details on available models and resources. Enphase also offers these parts in Enphase online store (<https://store.enphase.com/storefront/en-us/>) as accessory to Encharge energy storage system
5. The table below summarizes the minimum number of Encharge base units recommended to support startup of HVAC units with soft starter and 10A (2.4kW) of base load in off grid operation mode. Note that the number of required Encharge units may be different depending on the make, model, and age of the A/C units. The numbers below are based on limited tests on certain make and models of A/C units available in the market.

Nominal BTU refrigeration	HVAC tonnage	Compressor RLA/FLA	Before soft-start LRA	After soft-start LRA	Suggested Hyper Engineering SureStart	Enphase part number	Base load (A)	Total load (A)	Minimum number of Encharge base units
72K	6	20A-31A	140A-185A	56A-74A	SS1B16-32SN	SSTART-16-32A-1P-230V	10	84	11 x Encharge 3
60K	5	18A-30A	125A-135A	50A-54A	SS1B16-32SN	SSTART-16-32A-1P-230V	10	64	8 x Encharge 3
48K	4	16A-19A	100A-120A	38A-46A	SS1B16-32SN	SSTART-16-32A-1P-230V	10	56	7 x Encharge 3
36K	3	13A-16A	70A-80A	28A-36A	SS1B08-16SN*	SSTART-08-16A-1P-230V	10	46	6 x Encharge 3
24K	2	11A-13A	50A-63A	20A-25A	SS1B08-16SN	SSTART-08-16A-1P-230V	10	35	5 x Encharge 3
18K	1.5	9A-10A	44A-48A	18A-20A	SS1B08-16SN	SSTART-08-16A-1P-230V	10	30	4 x Encharge 3

*If the FLA of the AC unit is close to 16A, SS1B16-32SN OR SSTART-16-32A-1P-230V is suggested.

Contents

Design Considerations for Running Pumps and HVAC in Off grid with Encharge Energy Storage	1
Summary	1
1. Introduction	3
2. Theory of Operation and Control in Off-Grid Operation	4
2.1 Primary Control	4
2.2 Power Start™	4
2.3 Black Start	5
3. Electric Motors and Pumps in Off-Grid Operation	6
3.1 Case Study: 3 HP Pump with VFD	6
3.2 Case Study: 3 HP Pump without VFD	7
3.3 Summary of Enphase Ensemble Advantages for Pumps	8
4. HVAC Systems in Off-Grid Operation	8
4.1 Reading an HVAC Nameplate	8
4.2 Using a Soft Starter to Reduce Inrush Current	9
4.3 Sizing Storage for running HVAC in Off-Grid	10
4.4 Case Study: Half-Ton (0.5) AC	10
4.6 Case Study: Four-Ton AC with Soft Starter	11
4.7 Soft Starter Wiring Diagrams	13
4.8 Case Study Conclusion	14
5. Summary and Sizing Recommendations	15

1. Introduction

The addition of a multimode, grid agnostic, Energy Storage System (ESS) to a PV system provides many benefits, including providing backup power during grid outages. To get the most out of such Energy Storage System during grid outages and off-grid operation, one should understand how to best design the system for both on-grid and off-grid applications. Grid interactive PV systems convert sunlight into electric power that is consumed by loads in the home or delivered to the grid. This electric power is measured and accounted for by utility meters as energy. Generally, the goal of sizing a PV system is to offset the maximum amount of energy consumed by a home throughout a calendar year. The consequence of an undersized PV system is lower energy production than what is needed to offset a home's total energy use while being charged for the remaining energy sourced by the energy utility.

The goal of properly sizing a backup ESS, on the other hand, is to have the ESS with sufficient power rating to support the power requirements of the loads at any time during an off-grid operation such as a grid outage. Under sizing a backup ESS power rating in relation to the loads has swift consequences during a grid outage—it could lead to a blackout.

Encharge 3 and Encharge 10 storage systems are multimode ESS that can operate in off-grid mode and provide the grid forming functionality needed by PV inverters to keep operating during a grid outage. Encharge 10 has a continuous power rating of 3.84kW and a surge power rating of 5.76kW for ten seconds. This means that one Encharge 10 can supply 24A of surge current for ten seconds. This surge current is provided by 12 IQ8X-BAT microinverters in each Encharge 10. In addition to the surge power capability provided by IQ8X-BAT microinverters, our Ensemble Technology uses our proprietary control features known as primary control, Power Start™, and black start, which are described in the following section.

AC power is more dynamic than DC power and has characteristics beyond the continuous power rating that needs to be taken into consideration. Pure resistive loads such as water heaters, and electric heaters (e.g., irons, or water kettles) are simpler to design. Power draw from these types of loads is a product of current and voltage ($P = VI$). However, other types of loads, such as electric motors and compressors (e.g., HVAC systems, refrigerators, and pumps) store some current and redeliver it back to the power system. The difference between the apparent current and the real power the load uses is quantified by power factor. Power factor is defined as the real power divided by apparent power. When power factor of a load is equal to one, it means that its real power draw is equal to its apparent power draw. Motor loads have a power factor of less than one, which means the apparent power draw is more than the real power of the load. Moreover, in motor loads, additional current is needed when starting up a device, a phenomenon referred to as an inrush current. The increased current due to power factor and inrush current should be considered in any load analysis when sizing a backup system with ESS.

Note that the load is often expressed in current (Amps) or power (Watts) on load specifications on data sheets or nameplate labels found on appliances or equipment. Keep in mind, since $P = VI$ and voltage is considered to stay constant, a load analysis may switch between current or power specifications.

2. Theory of Operation and Control in Off-Grid Operation

2.1 Primary Control

The Enphase Ensemble system uses a distributed primary control system (primary control, in short), to balance the instantaneous generation and load. The inverters are programmed to automatically increase their power injection as voltage and frequency drop, creating a corresponding response which is often referred to as “droop” control. The primary control in our systems is very fast and is managed autonomously by our proprietary Application-Specific Integrated Circuit (ASIC) chips in each microinverters.

2.2 Power Start™

While primary control is at the heart of Enphase Ensemble system for power-sharing, it also employs a proprietary brownout control algorithm, called Power Start™ to help cope with large inrush loads. This algorithm detects when the inverter approaches its maximum power limit and then begins to actively reduce voltage and frequency to maintain the inverter at its limit using active feedback. Because many devices (such as pumps and compressors) draw less current as the voltage and frequency reduce, this temporary reduction in current, known as a brownout, is often enough to keep the inverter within its operating limits. This is known as ride-through, and allows equipment, such as pumps and HVACs, to turn on using significantly less power than otherwise required. (See the following graph.)

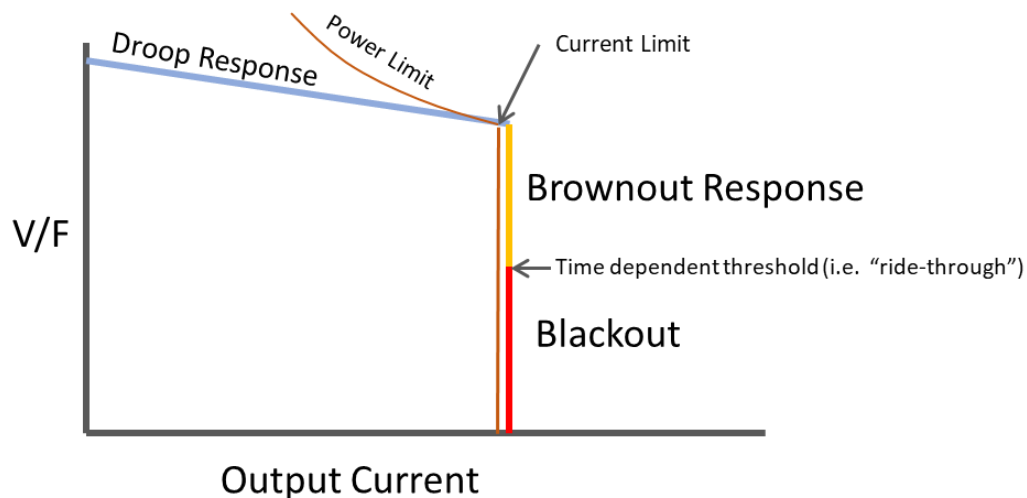

Figure 1: Power Start™ brownout control and ride-through capability of the IQ8X-BAT microinverters enable reduction of system voltage and frequency to aid startup of motors and compressors.

The image below demonstrates this technique with an air conditioner start up. The bottom transient shows a typical grid-tied compressor startup. As shown, the air conditioner completes starting up in 150ms with little change in the voltage. The current peaks near 200A. The top transient shows the same air conditioner starting up in off-grid operation. The surge quickly exhausts the droop response that triggers the Power Start™ algorithm, creating a brownout response, which in turn limits the current. Because the compressor is now drawing less power, it takes longer to startup (~600ms), but once it does, the current reduces, and normal voltage and frequency are restored.

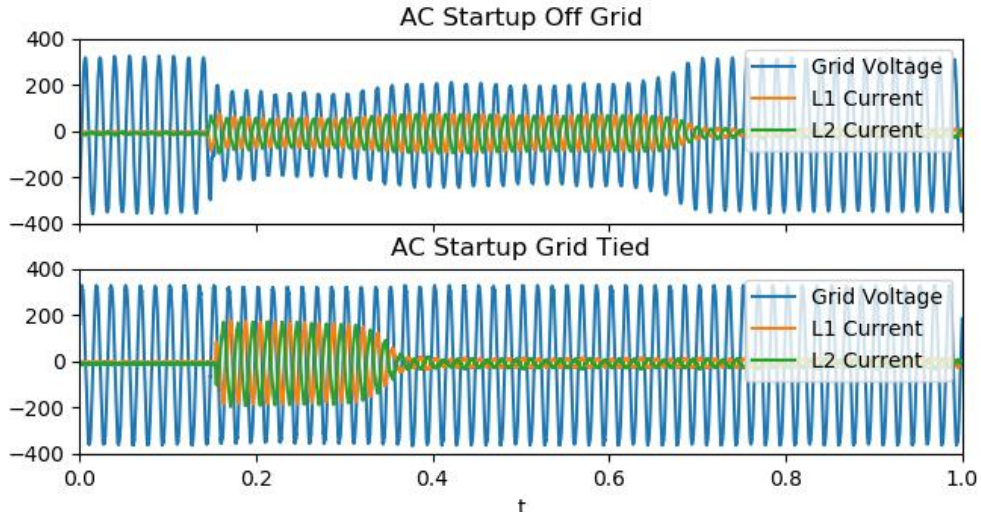

Figure 2: Voltage and current of the AC unit with a soft starter in grid-tied and off-grid operation modes. Power Start™ technology reduces the voltage in off-grid operation to enable startup of the compressor.

2.3 Black Start

While Power Start™ improves the system's resilience to temporary surges, a large enough surge can cause the voltage and frequency to collapse to a level severe enough that the system automatically shuts down (i.e., "blackout"). The system shuts down to limit the extent and duration that brown-out conditions affect both the inverters and the loads. Severe and/or sustained brown-out conditions can cause premature wear out of motors. The IQ8X-BAT microinverters in Encharge are programmed to shut down if the voltage and frequency drop below pre-defined limits for more than a set time duration, known as ride-through conditions.

When such a system shutdown occurs, the Enpower smart switch (if installed) automatically connects the system back to the grid so that your home gets power from the grid. If there is no grid present, the system attempts to restart automatically. Attempting to re-energize a de-energized system is known as a "black start". Enpower starts this procedure by first disconnecting the Encharge branch circuits from the system. This allows the IQ8X-BAT microinverters within Encharge to restart and reach full voltage under no-load conditions. The Enpower then replenishes its backup power source directly from the Encharge branch circuit(s) so that it has enough stored energy to attempt further restarts, if required. Once Enpower has recharged its power supply, it attempts to energize the home system by closing the Encharge branch relay. If there is too much load and the system collapses, the process repeats automatically after a few minutes.

3. Electric Motors and Pumps in Off-Grid Operation

Electric motors such as well pumps, pressure pumps, and booster pumps, typically found in homes, have an inrush current when first turned on. This startup current, known as Locked Rotor Amperage (LRA), lasts for a fraction of a second. However, depending on the make, model, size, and application of the motor, it could be four to eight times more than the motor's Running Load Amperage (RLA). RLA is also sometimes referred to as Full-Load Current (FLC). Power ratings for electric motors are typically expressed in Horsepower (HP). One HP is equivalent to 745.7 Watts. Note that electric motors typically have a power factor in the range of 0.7 to 0.9, and a rule of thumb estimate of electric motors is 0.85 during normal run time. The power factor when electric motors are turned on is less than their run time power factor, and it could be in the range of 0.5 to 0.6.

The following table shows FLC and LRA of 1/5 HP to 7 1/5 HP single-phase electric motors for 110V to 120V and 220V to 240V voltage ranges from NEC 2017 tables 430.248 and 430.251(A). Note that if the actual ratings of the motor nameplate are available, the values from the nameplate should be used. If the nameplate values are not available, then use the values in the following table as estimated values.

Horsepower	110Volts- 120Volts		220Volts- 240Volts	
	RLA/FLC (A)	LRA (A)	RLA/FLC (A)	LRA (A)
1/2	9.8	58.8	4.9	29.4
3/4	13.8	82.8	6.9	41.4
1	16	96	8.0	48
1 1/2	20	120	10	60
2	24	144	12	72
3	34	204	17	102
5	56	336	28	168
7 1/2	80	480	40	240

A variable frequency drive (VFD) starter reduces the startup current of electric motors. VFD reduces voltage and frequency of the electricity supplied to the motor during startup to reduce its inrush current. Even though VFDs reduce the inrush current, they introduce harmonics to the grid and typically generate non-sinusoidal current waveforms that are difficult to support in off-grid mode, especially if the inverters do not have proper and fast control capabilities. Enphase IQ8X-BAT microinverters inside the Encharge storage system can easily support such demanding current waveforms due to fast control loops and advanced power management features, including Power Start™.

3.1 Case Study: 3 HP Pump with VFD

The waveform below shows an example of a 3 HP electric motor with VFD which was successfully supported by two Encharge 10 and two Encharge 3 (Eight Encharge base units) units. The continuous current rating of both Encharge units is 42.6A, with a peak current capability of 64A. The peak current withdrawn by the 3 HP pump with VFD is 8A (5.7A RMS). As seen in the following graph, the Encharge 10 and 3 units successfully supported the startup of this pump. Based on the information about the amount of current that was drawn by the pump, even two Encharge 3 units could do the job.



Figure 3: Voltage and current waveforms of an electric motor with VFD. Note the distortions on the current (blue) waveform.

3.2 Case Study: 3 HP Pump without VFD

At another site, we were able to easily run a 3 HP pressure pump (also known as a booster pump) without a VFD in an off-grid mode with seven Encharge 3 batteries. We found that the pump typically consumed about 64A to 80A (RMS) surge during startup. When operating in an off-grid mode, the two Encharge 10 and one Encharge 3 (total of seven Encharge base units) provide up to 58.8A of startup current to run the pump.



Figure 4: Nameplate of a Three HP Pump with no VFD.

The Encharge storage system consistently started the pressure pump. The Ensemble Power Start™ allowed the voltage to drop down to the point that the pump ran when off-grid. Specifically, the voltage dropped from 240V to approximately 186V as the pump started up by applying the smart brownout capability of the Encharge IQ8X-BAT microinverters, as explained in section two.

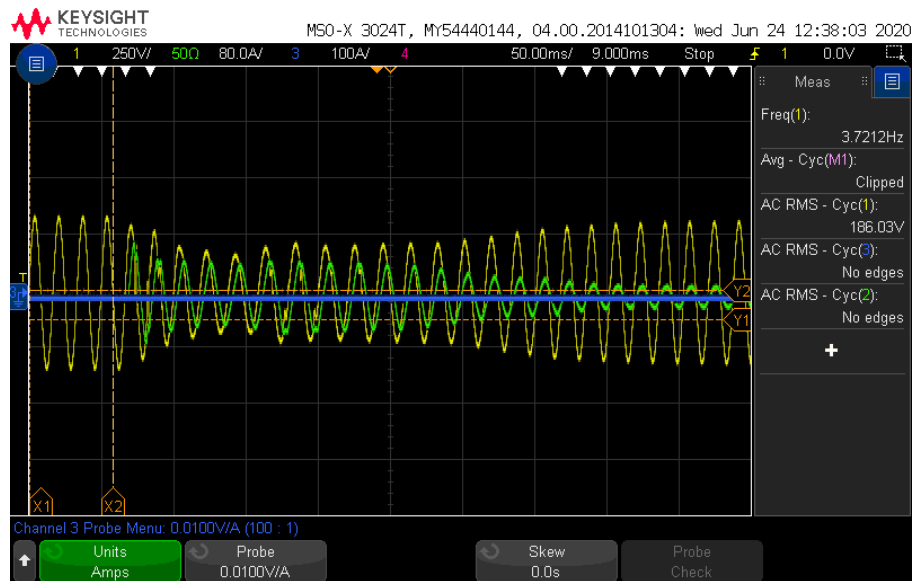

Figure 5: Voltage and current waveforms of the 3 HP pump during startup and demonstration of the Power Start™ capability of Encharge

3.3 Summary of Enphase Ensemble Advantages for Pumps

The Ensemble system can start up electric motors and pumps with or without VFD due to its very fast response time, proprietary algorithms implemented in the primary controls and Power Start™. This enables the installations to be the right size according to customer's needs, versus competitors who would require additional large storage units to provide the power required to turn on such pumps.

4. HVAC Systems in Off-Grid Operation

There are several types of HVAC systems. For sizing purposes, the primary consideration is the compressor motor. Most common compressors are scroll type, however there are also rotary or piston types. The compressor can operate as a single stage (where it is on or off), a multiple stage (where it is run at different power levels), or as a variable speed. With the exception of variable speed or inverter based, HVAC units typically have an increased current on startup, also called Locked Rotor Amperage (LRA). The LRA could be as high as four to eight times more than their Running Load Amperage (RLA) or Full Load Amperage (FLA), depending on the make, model and age of the unit. The startup current (LRA) usually lasts for a few seconds and after that only the RLA is needed to keep your AC unit running. Variable speed HVAC systems typically do not have an inrush startup current. However, as a nonlinear load there are other special considerations.

Providing the startup current is the challenging part of running ACs in backup/off grid mode, as other vendors often require the addition of multiple batteries beyond what you need. In Encharge storage systems, the surge current is provided by the IQ8X-BAT microinverters and the advanced power management feature in Ensemble, including Power Start™.

4.1 Reading an HVAC Nameplate

It is important to properly read the nameplate of HVAC systems and to understand the RLA and LRA definition before designing storage system that support HVAC in backup/off-grid operation. The following

image shows an example of HVAC nameplate. The important parameters on the nameplate for sizing storage are RLA and LRA.



Figure 6: Example HVAC nameplate

Full Load Amps (FLA)

Full Load Amps, also referred to as Running Load Amps (RLA), is the continuous current expected under a steady load. Since the load may be less than the motor rating, the current could be less than rated. The load may be less than the rating, so the RLA provides the expected value when the compressor is running. In Figure 6, the compressor lists 15.5 RLA on the nameplate.

Locked Rotor Amps (LRA)

The HVAC nameplate provides information you need to size the backup ESS. The most critical value for ESS sizing in backup systems is the Locked Rotor Amps (LRA) rating of HVAC. LRA relates to the expected inrush current during startup. In the previous example, the compressor has 105.5 LRA on the nameplate. Under real world conditions, it could be a higher or lower value, depending on various factors such as age of the product. It is important to keep in mind that LRA is an RMS current reading. In principle, the ESS peak current output should exceed the LRA and the base load that would be on during the startup of the HVAC.

4.2 Using a Soft Starter to Reduce Inrush Current

You can reduce large LRA values with a soft starter as seen in Table 2. Examples of soft starters include:

- Hyper Engineering SureStart SS1B08-16SN (230V, 60/50Hz, 08-16 FLA) for scroll compressors
- Hyper Engineering SureStart SS1B16-32SN (230V, 60/50Hz, 16-32 FLA) for scroll compressors
- Hyper Engineering SureStart SS0B12-20SN (115V, 60/50Hz, 12-20 FLA) for rotary/piston compressors

For details and data sheets for SureStart, see http://www.hypereng.com/single_phase.html. Enphase also has these parts in the Enphase store, corresponding part numbers mentioned in table below:

Typical LRA before and after installing soft starter¹

¹ http://www.hypereng.com/single_phase.html

Nominal kBTU refrigeration	HVAC ton	Motor size	Compressor RLA/FLA	Before soft-start LRA	After soft-start LRA	Suggested Hyper Engineering SureStart	Enphase part number
72K	6	6hp	20A-31A	140A-185A	56A-74A	SS1B16-32SN	SSTART-16-32A-1P-230V
60K	5	5hp	18A-30A	125A-135A	50A-54A	SS1B16-32SN	SSTART-16-32A-1P-230V
48K	4	4hp	16A-19A	100A-120A	38A-46A	SS1B16-32SN	SSTART-16-32A-1P-230V
36K	3	3hp	13A-16A	70A-80A	28A-36A	SS1B08-16SN*	SSTART-08-16A-1P-230V
24K	2	2hp	11A-13A	50A-63A	20A-25A	SS1B08-16SN	SSTART-08-16A-1P-230V
18K	1.5	1.5hp	9A-10A	44A-48A	18A-20A	SS1B08-16SN	SSTART-08-16A-1P-230V

*If the FLA of the AC unit is close to 16A, SS1B16-32SN OR SSTART-16-32A-1P-230V is suggested.

4.3 Sizing Storage for running HVAC in Off-Grid

2017 NEC 710.15 (A) requires that the standalone power source be capable of supporting the largest load—often the HVAC system. HVAC is also an example of a non-resistive load with a startup current much higher than the continuous operating current. Multimeters with current clamp often have an “inrush” mode to measure this, a term also used to describe the startup current. There are a number of HVAC systems, (except for variable speed or inverter-based systems) that require increased current during startup.

To support the startup of your AC units in backup/off-grid mode with Encharge, do the following:

1. Install a soft starter on your AC unit. We suggest SureStart from Hyper Engineering (http://www.hypereng.com/single_phase.html). Use the previous table and the manufacturer guides to find the right Soft Starter model for the HVAC unit. Enphase store also has these parts as accessories for Encharge energy storage system.
2. Measure the reduced LRA of the unit after installation of the soft starter, while it is connected to the grid, to make sure the surge power rating of Encharge units being installed on the site can support the LRA of the HVAC unit. Each Encharge 3 provides 8A RMS of surge current for ten seconds using its four internal IQ8X-BAT microinverters. Note that if there is PV generation during HVAC start up, the startup is easier and you can even have some other loads running during the startup of the AC unit.
3. If your specific HVAC unit startup current, after the installation of soft starter, requires additional units to meet the surge current requirements, you can take advantage of the Encharge system modularity and optimize the number of batteries you need. You can add an additional Encharge 3.
4. Note that it may take a few iterations for the soft starter to learn your AC behavior during startup. After installing the soft starter, we recommend you start it for about ten times in grid-connected mode to allow it to learn the behavior of your AC startup.

4.4 Case Study: Half-Ton (0.5) AC

Make and model: LG LW6017R
 HVAC unit data sheet: <https://www.lg.com/us/air-conditioners/lg-LW6017R-window-air-conditioner>
 FLA: 4.9 A
 LRA: not captured on data sheet
 Size: 6000 BTU / 0.5-ton

Total number of Encharge units in this installation is two Encharge 3 units, with a total rated capacity of 6.6kWh, 2.56kW continuous power, and 3.84kW surge power for ten seconds.

The following scope capture shows the startup of this AC unit in an off-grid condition. Two Encharge 3 units can successfully support the startup of this AC unit. The following graph shows that this AC unit does not have an inrush current and that the peak current is 7.4A (5.2A RMS). Note that even one Encharge 3 with a total of 8A RMS peak current for ten seconds, and 5.3A continuous current can support these half-ton AC units.

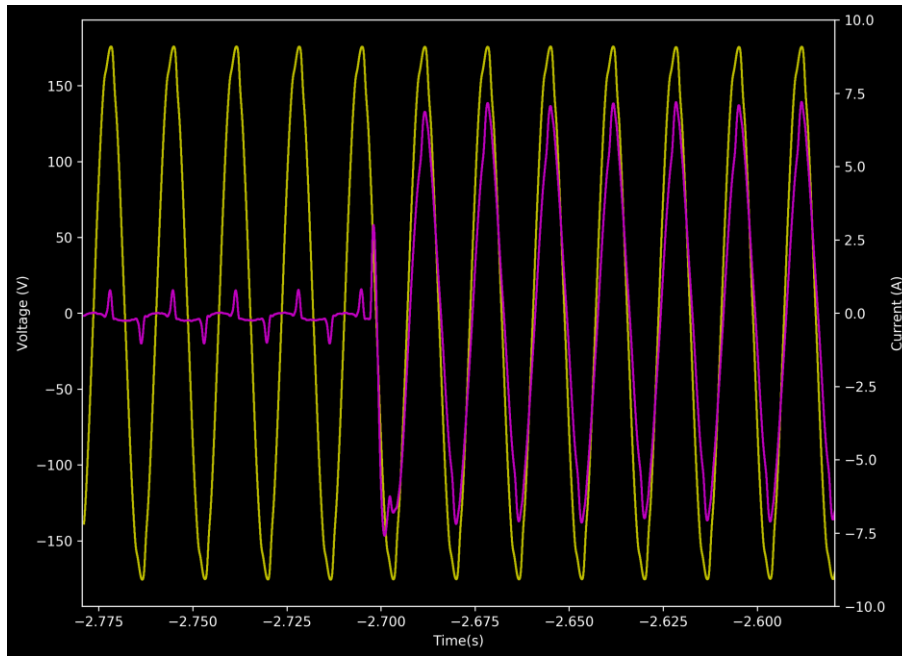

Figure 7: LG LW6017R window air conditioner 6000 BTU, 520W, 120V 4.9A

Summary of Enphase Ensemble Advantages for Small AC Units

Encharge Power Start™ technology and primary control make supporting small AC units in off-grid mode possible with minimal amount of battery storage on site. To support your AC units, you do not need to purchase additional battery storage units that exceed the actual need for the site. Take advantage of the modularity of Encharge and use multiple Encharge 3 units, and customize the storage size that best fits the site.

4.6 Case Study: Four-Ton AC with Soft Starter

The following case study shows how a soft starter reduces the inrush current on a four-ton HVAC system. The details for the HVAC unit are as follows:

Make: Carrier Corporation

Model: 24AAA548A300

HVAC unit data sheet: <https://www.carrierenterprise.com/24aaa548a003>

FLA: 15.5A

LRA: 105.5A

Size: 48,000 BTU / 4-ton (This is interpreted from the model number. The **48** in the model number, 24AAA**548**A300, refers to 48kBTU/four-ton capacity of the unit. See the data sheet on how to read the model number)

The total number of Encharge units in this installation is five Encharge 3 units, with total rated capacity of 16.6kWh, 6.4kW continuous power, and 9.6kW surge power for 10 seconds.

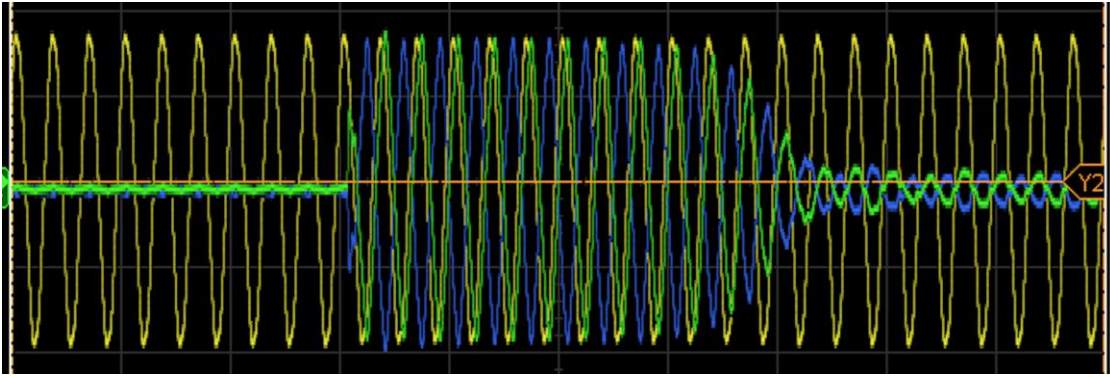

Figure 8: Scope Capture of a 4-ton HVAC startup current and voltage without soft starter installed. Yellow Line is the Line to Line Voltage, Green Line is Line 1 Current, and Blue Line is Line 2 Current. The graph shows an inrush current of 110A RMS without a soft starter in grid connected mode.

The scope capture shows that without the soft starter installed, both the fan and compressor start up at the same time and the inrush lasts for approximately 12 cycles (200ms).

Unsuccessful Attempt with 8A to 16A Soft Starter (SS1B08-16SN OR SSTART-08-16A-1P-230V)

The first attempt at installing a soft starter failed to reduce the inrush current. The FLA of the air conditioner rating is 15.5A, which suggests that the proper model is an 8A to 16A soft starter (Hyper Engineering SureStart SS1B08-16SN OR Enphase part number SSTART-08-16A-1P-230V). Installing the 8A to 16A soft starter did not reduce the LRA. This model also has a recommended LRA design limit of 90A lower than the nameplate 105.5A AC-RMS LRA.

Successful installation with 16 to 32A Soft Starter (SS1B16-32SN OR SSTART-16-32A-1P-230V)

Replacing this model with a 16A to 32A soft starter (Hyper Engineering SureStart SS1B16-32SN OR Enphase part number SSTART-16-32A-1P-230V) successfully reduced the inrush current. With the soft starter installed, the compressor startup occurred approximately 500ms after the fan startup occurred.

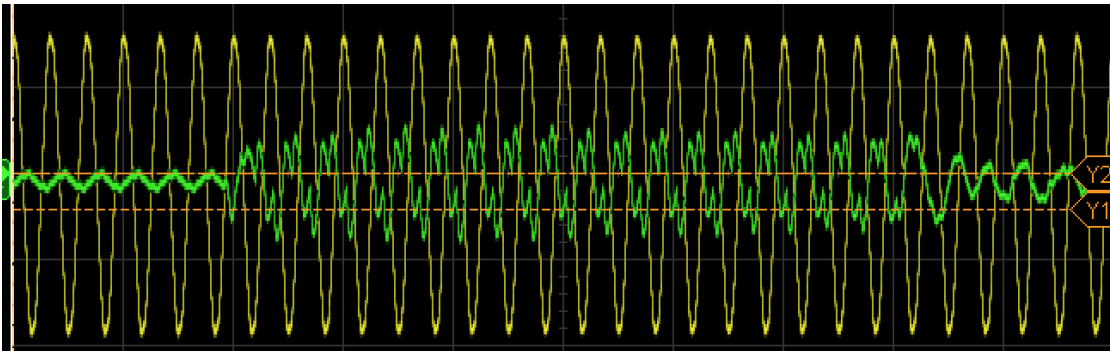

Figure 9: Scope capture of a four-ton AC startup with soft starter installed. The graph shows an inrush current of 37.99A RMS.

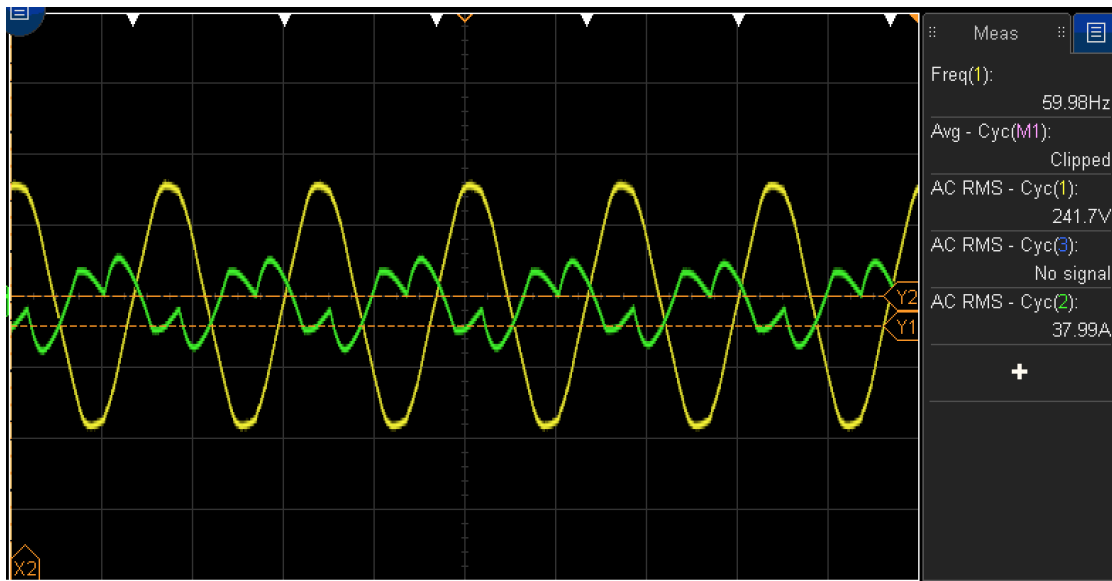

Figure 10: Scope capture of four-ton AC with soft starter installed, zoomed in to show scope reading of 37.99A

4.7 Soft Starter Wiring Diagrams

When wiring the soft starter, it was not clear which conductors ran to the fan motor (OFM) and which wires ran to the compressor. We followed the wiring as it ran from the wiring compartment of the air conditioner to see which wires ran to the compressor and which ran to the fan. The compressor power conductors were larger than the fan conductors. The red wires in the previous diagram were yellow in our AC.

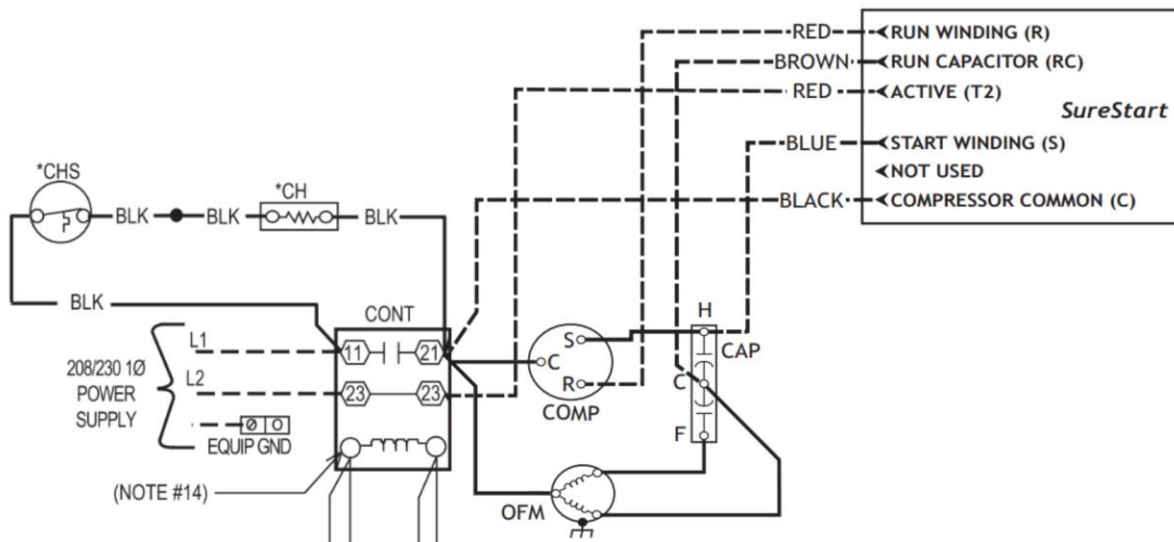

Figure 11: Wiring diagram for case study with four-ton AC unit²

Wiring Diagram Legend

- CONT – Start contactor included with
- COMP – AC compressor

² http://www.hypereng.com/single_phase.html

- OFM – Outdoor fan motor
- CAP – Start capacitor included with AC
- *CH - Crankcase heater (did not exist in this AC)
- *CHS – Crankcase heater switch (did not exist in this AC)

Actual AC Compressor and Fan Conductor Wiring with SureStart Installed

- Larger yellow conductor: from run (R) terminal of compressor to run winding (R) terminal of SureStart
- Larger black conductor: from common (C) terminal of compressor to contactor terminal 21
- Blue conductor: from start (S) terminal of compressor to herm (H) terminal of capacitor
- Smaller yellow conductor: from fan to common (C) terminal of capacitor
- Smaller black conductor: from fan to contactor terminal 21
- Brown conductor: from fan to fan (F) terminal of capacitor



Figure12: Air conditioner wiring compartment with soft starter installed

4.8 Case Study Conclusion

The Hyper Engineering SureStart SS1B16-32SN soft starter reduced the inrush current of the AC from 105.5A to 37.99A. The installation of the soft starter resulted in a 64% reduction in the inrush current, and allowed the AC to start in off-grid mode with five Encharge 3 units. Five Encharge 3 units are rated to provide 40A of current for up to ten seconds.

5. Summary and Sizing Recommendations

Enphase recommends a minimum number of Encharge base units to support HVAC systems with soft starter and a 10A (2.4kW) of base load, however, it may need to have higher number of Encharge units depending on the typical base load prior to startup and effectiveness of the soft starter on specific make, model, and age of the HVAC units.

Note that if multiple HVAC systems are backed up, a safety margin should always be added as additional base load in running the HVAC unit and when sizing an energy storage system based on inrush.

Nominal BTU refrigeration	HVAC tonnage	Compressor RLA/FLA	Before soft-start LRA	After soft-start LRA	Suggested Hyper Engineering SureStart	Enphase part number	Base load (A)	Total load (A)	Minimum number of Encharge base units
72K	6	20A-31A	140A-185A	56A-74A	SS1B16-32SN	SSTART-16-32A-1P-230V	10	84	11 x Encharge 3
60K	5	18A-30A	125A-135A	50A-54A	SS1B16-32SN	SSTART-16-32A-1P-230V	10	64	8 x Encharge 3
48K	4	16A-19A	100A-120A	38A-46A	SS1B16-32SN	SSTART-16-32A-1P-230V	10	56	7 x Encharge 3
36K	3	13A-16A	70A-80A	28A-36A	SS1B08-16SN*	SSTART-08-16A-1P-230V	10	46	6 x Encharge 3
24K	2	11A-13A	50A-63A	20A-25A	SS1B08-16SN	SSTART-08-16A-1P-230V	10	35	5 x Encharge 3
18K	1.5	9A-10A	44A-48A	18A-20A	SS1B08-16SN	SSTART-08-16A-1P-230V	10	30	4 x Encharge 3