

Instructions to use the Rapid shutdown (RSD) switch connections

Each Enphase Storage system with IQ8 PV requires the presence of a rapid shutdown (RSD) switch. Rapid shut down switch is needed to disconnect all PV panels, battery and generator systems in the building/home to ensure the safety of maintenance technicians. When the RSD switch is engaged, the Enphase storage system will be shutdown and the home is connected to the grid.

The contents of the Rapid shutdown (RSD) switch connections and how to use them are described below:

1 Components that are needed for RSD connection

S.No	Component	Source of Components	Qty
1	RSD switch	RSD kit (SKU: EP200G-NA-02-RSD)	1
2	NEC label 1	RSD kit (SKU: EP200G-NA-02-RSD)	1
3	NEC label 2	RSD kit (SKU: EP200G-NA-02-RSD)	1
4	Cable head assembly	IQ System Controller 2 literature kit	4
5	12 AWG wire (for RSD connections)	Provided by Installer	Length as required
6	8-14 AWG wire (for Ground bar)	Provided by Installer	Length as required

2 Wiring the auxiliary contacts in IQ System Controller 2

- A) The IQ System Controller 2 comes with multiple auxiliary contacts as indicated in Figure 1.
- B) The contacts NC3 and NC4 are for wiring the RSD (indicated in the red box in Figure 1).
- C) The IQ System Controller literature kit comes with cable assembly header which is shown in Figure 2a.
- D) Insert the ferrule of the cable header assembly to the feed through header which is indicated in Figure 2b.
- E) Tighten the screws on the top (torque 0.22Nm to 0.25Nm) to secure the wires.
- F) Repeat steps D and E to complete wiring of other 3 terminals of NC3 and NC4.

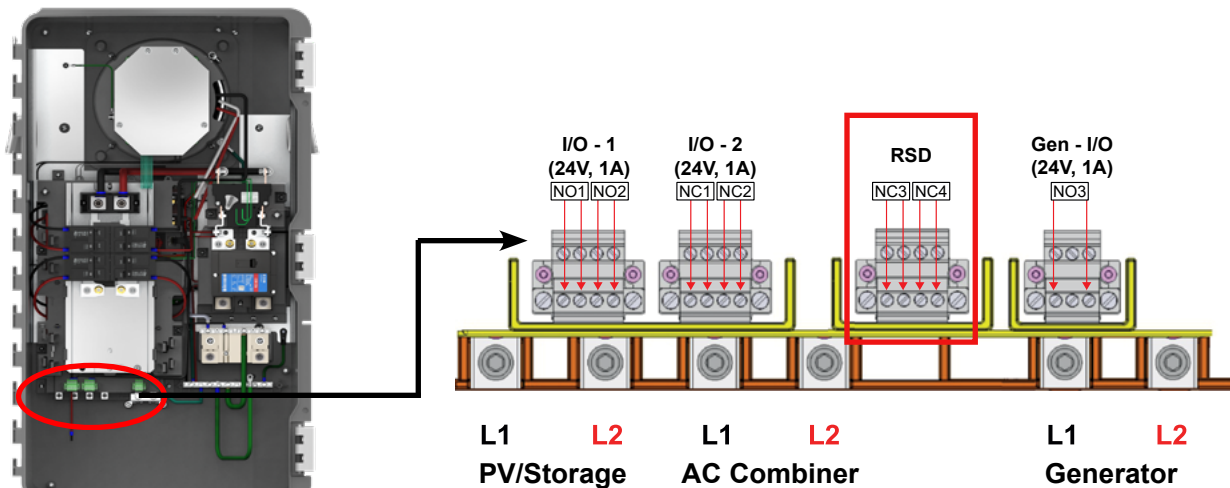

Figure 1: Layout of auxiliary contacts in IQ System Controller, Terminals for connecting RSD are indicated in red

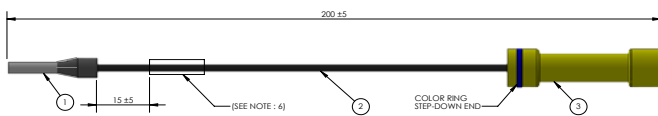
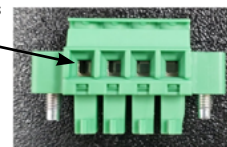

Figure 2a: Cable header assembly

1. Insert wires here



2. Tighten these screws to hold the wires in place



Figure 2b: Feed through header



3 Wiring the switch inside the Rapid Shutdown (RSD) enclosure

- Open the front face of the RSD by loosening the two screws on the front face.
- Create wiring conduit in the top/bottom portion of the enclosure. There are knock outs provided for this.
- Screw in 12AWG wires to terminals marked 1,2,3 and 4 of the switch. Torque values can be found in the below table.
- Screw in 8-14 AWG wire to the Ground bar within the enclosure. Torque values can be found in the below table.
- Draw the wires out through the conduit which has been created in the enclosure.
- Secure the switch to the rear plate of the enclosure by torquing the screws as indicated in figure 3. There are 2 screws to be torqued. The screws can be found in the RSD kit.
- Fit the front face and torque the screws. Torque values can be found in the below table.
- The torque rating of each of these wires/screws are as below:

S.No	Point of Torquing	Torque (Nm)
1	Terminal 1,2,3,4	1.8
2	Ground	0.8-1.4
3	Front cover	1.5
4	Screws to secure Switch	0.6

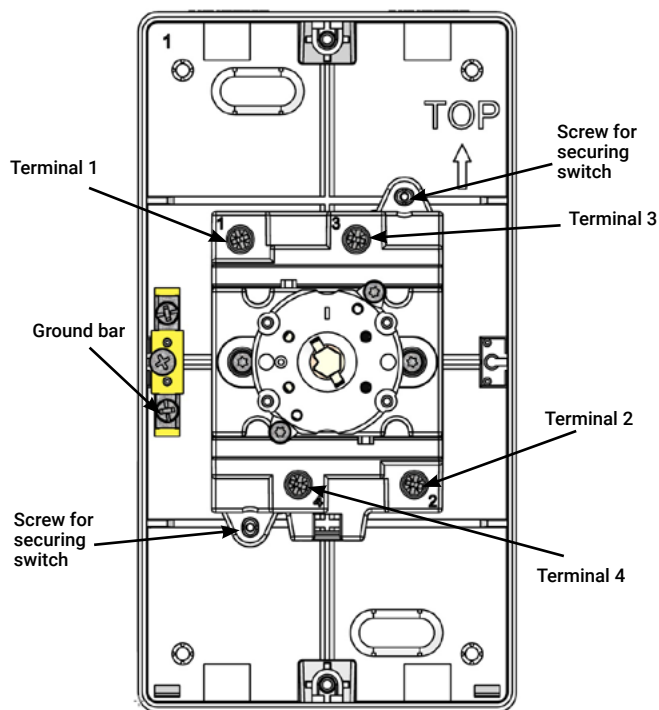

Figure 3: Final RSD wiring

4 Mounting the RSD

- Identify a location which is near the IQ System Controller smart switch to mount the RSD. Please note that IQ System Controller and RSD cannot be more than 200 ft apart.
- There are 2 mounting points on the back plate of the enclosure. They are marked by red boxes in Figure 4 below.
- Installers can use any type of mounting as long as they are not exceeding the diameter of each fixing point.
- It is recommended that installers use #8 screw, with a minimum recommended length of 1.5 inches. The type of screw is to be determined by installer based on where they wish to mount the RSD.

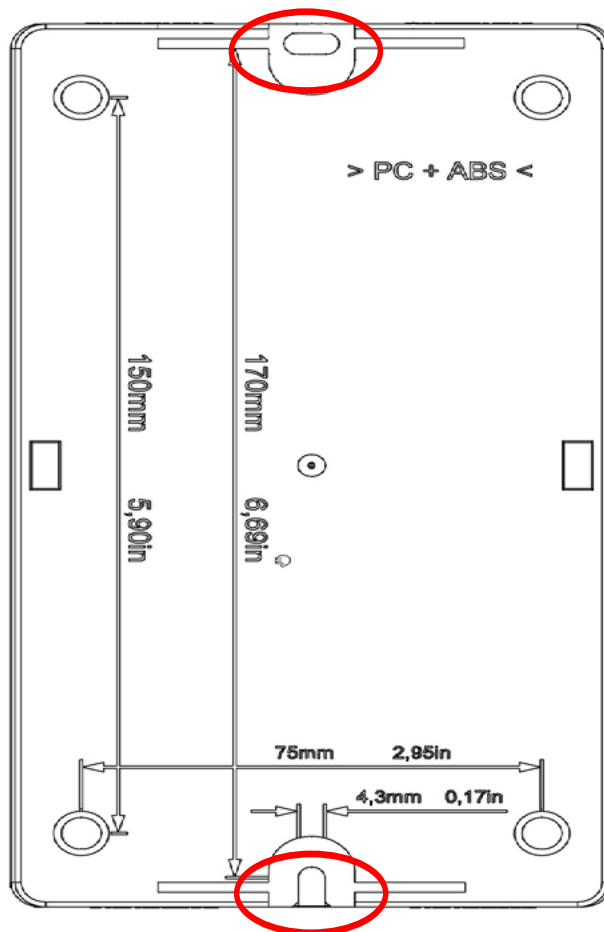

Figure 4: Mounting location in backplate of RSD

5 Connect wires from RSD and IQ System Controller

- Connect the cables connected from Terminal 1 and 2 of the RSD to the yellow portion of the cable header assembly (Figure 2) from NC3 and crimp it.
- Connect the cables connected from Terminal 3 and 4 of the RSD to the yellow portion of the cable header assembly (Figure 2) from NC4 and crimp it. Refer to Figure 5 and table below.
- Connect the cable from the grounding bar to the Ground bar in IQ System Controller.
- Ensure Cables are properly sheathed and are not lose or exposed to environment.

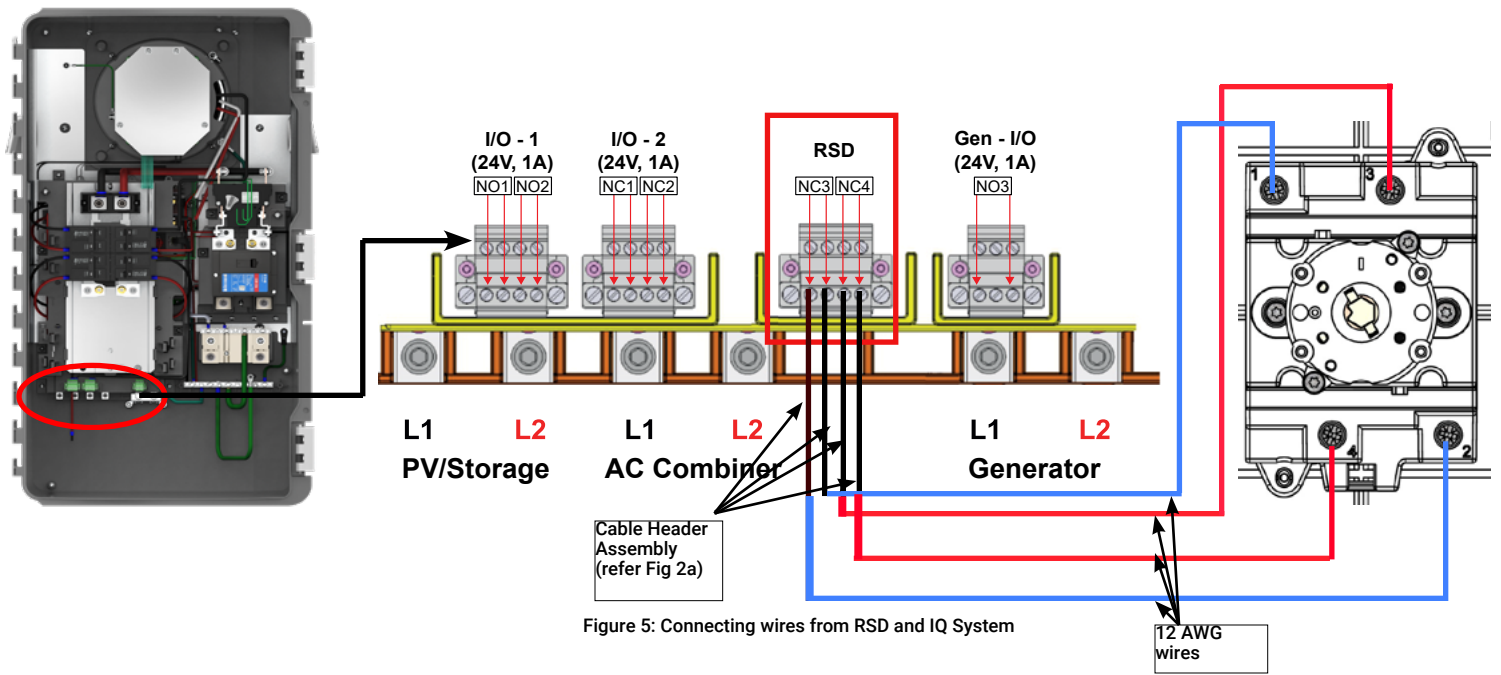

Figure 5: Connecting wires from RSD and IQ System

Dry Contact Terminals		RSD Terminals to be connected
NC3	Terminal 1	Terminal 1
	Terminal 2	Terminal 2
NC4	Terminal 1	Terminal 3
	Terminal 2	Terminal 4

6 Functional tests

- Use the Enphase Installer App to check if the RSD is working as desired. When the RSD is engaged (turned to OFF position), all the relays except the MID will be open. Only the MID relay will be closed. Hence effectively isolating the home from the PV, battery and generator.
- In order to check if the RSD is functioning as required, open the ITK and go to the IQ System Controller page.
- Turn the RSD rotary handle to OFF position.
- In the Enphase Installer App's IQ System Controller page, click on "View Live details".
- In the view live details page, the relay status should be as shown in Figure 6 below. The MID relay should be closed and all other relays should be in open position.
- When RSD handle is shifted to ON position, the IQ System Controller goes back into functioning normally as it was.

MID	EC1 L1	EC1 L2	NFT L1	NFT N
Closed	Open	Open	Open	Open

Figure 6: ITK checking of Relay status

7 Complete the installation by affixing the labels

- In order to identify the Rapid shut down switch the following label (in Figure 7) needs to be pasted at a distance of not more than 3ft (1m) from the RSD, as mandated by the NEC code.

RAPID SHUTDOWN SWITCH FOR SOLAR PV SYSTEM

Figure 7: Label for identifying the RSD

- In order to earmark the parts of the array which will be shut down by using the RSD the following sticker (Figure 8) needs to be pasted in the location specified by the Authority having jurisdiction or at a distance of not more than 3ft (1m) from from the RSD, as mandated by the NEC code.

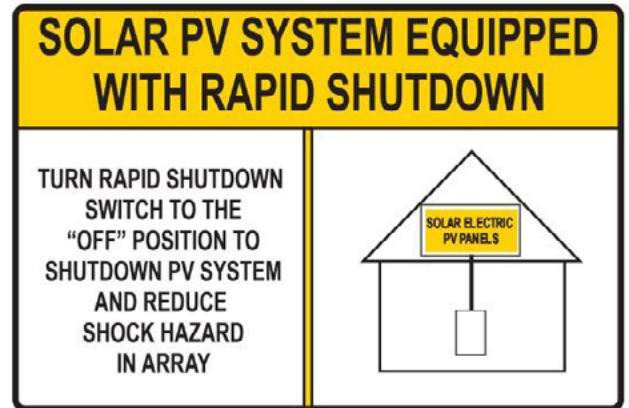

Figure 8: Sticker for showing portions of PV array which will be shut down using RSD

8 Instructions for initiating Rapid Shut down and IQ System Controller System shut down

Rapid shut down of the system can be initiated by turning the handle of the RSD to the OFF position. With this one step the entire Enphase system (PV arrays, IQ Battery, generators connected to IQ System Controller) is shut down and the regulatory requirement for rapid shut down are also met.

NOTE: For more details of the RSD switch options and wiring instructions, please refer to IQ System Controller 2 QIG or the Enphase Energy System design guide

SAFETY

IMPORTANT SAFETY INSTRUCTIONS. SAVE THESE INSTRUCTIONS. This guide contains important instructions that you must follow during installation and maintenance of the Enphase IQ System Controller. Failing to follow any of these instructions may void the warranty (enphase.com/warranty).

In Case of Fire or Other Emergency

In all cases:

- If safe to do so, switch off the AC breaker for the IQ System Controller circuit, and if an isolator switch is present, switch off the AC isolator for the IQ System Controller circuit.
- Contact the fire department or other required emergency response team.
- Evacuate the area.

In case of fire:

- When safe, use a fire extinguisher. Suitable types are A, B, and C dry chemical fire extinguishers. Additional extinguishing media include carbon dioxide, or alcohol-resistant foams.

In case of flooding:

- Stay out of water if any part of the IQ System Controller or wiring is submerged.
- If possible, protect the system by finding and stopping the source of the water, and pumping it away.
- If water has contacted the UNIT, call your installer to arrange an inspection. If you are sure that water has never contacted the battery, let the area dry completely before use.

In case of unusual noise, smell or smoke:

- Ensure nothing is in contact with the IQ System Controller or in the venting area on top of the IQ System Controller.

Safety and Advisory Symbols

	DANGER: This indicates a hazardous situation, which if not avoided, will result in death or serious injury.
	WARNING: This indicates a situation where failure to follow instructions may be a safety hazard or cause equipment malfunction. Use extreme caution and follow instructions carefully.
	NOTE: This indicates information particularly important for optimal system operation. Follow instructions carefully.

Safety Instructions

	DANGER: Risk of electric shock. Risk of fire. Only qualified electricians should install, troubleshoot, or replace the IQ System Controller.
	DANGER: Risk of electric shock. Risk of fire. Do not attempt to repair the IQ System Controller. Tampering with or opening the IQ System Controller will void the warranty. If the IQ System Controller fails, contact Enphase Customer Support for assistance at enphase.com/en-us/support/contact .

Safety Instructions, continued

	DANGER: Risk of electric shock. Do not use Enphase equipment in a manner not specified by the manufacturer. Doing so may cause death or injury to persons, or damage to equipment.
	DANGER: Risk of electric shock. Do not install the IQ System Controller without first removing AC power from the photovoltaic system and ensuring that the DC switch on the Enphase IQ Batteries are off. Disconnect the power coming from the photovoltaics and ensure that the DC switch on the IQ Batteries are off before servicing or installing.
	DANGER: Risk of electric shock. Risk of fire. Do not work alone. Someone should be in the range of your voice or close enough to come to your aid when you work with or near electrical equipment.
	DANGER: Risk of fire. Do not allow or place flammable, sparking, or explosive items near the IQ System Controller.
	DANGER: Risk of electric shock. In areas where flooding is possible, install the IQ System Controller at a height that prevents water ingress.
	WARNING: Risk of equipment damage. IQ System Controller is shipped and stored on its back. The upright position is only needed when installed.
	WARNING: You must install the IQ System Controller only on a suitable wall using an Enphase wall-mount bracket.
	WARNING: Before installing or using the IQ System Controller, read all instructions and cautionary markings in this guide and on the equipment.
	WARNING: Do not install or use the IQ System Controller if it has been damaged in any way.
	WARNING: Do not sit on, step on, place objects on, or insert objects into the IQ System Controller.
	WARNING: Do not place beverages or liquid containers on top of the IQ System Controller. Do not expose the IQ System Controller to flooding.
	NOTE: Perform installation and wiring, including protection against lightning and resulting voltage surge, in accordance with all applicable local electrical codes and standards.
	NOTE: Because IQ Battery is grid forming, you must install signage in accordance with NEC articles 705, 706, and 710.
	NOTE: Using unapproved attachments or accessories could result in damage or injury.
	NOTE: Install properly rated over current protection as part of the system installation.
	NOTE: To ensure optimal reliability and to meet warranty requirements, the IQ System Controller must be installed and/or stored according to the instructions in this guide.
	NOTE: The IQ System Controller is compatible only with the IQ Gateway or Envoy S-metered communications gateway properly fitted with USB hub, USB radios, and production and Consumption/PCS CTs . The IQ Gateway is required for operation of the IQ System Controller. Earlier versions of the Enphase Envoy communications gateway are incompatible.
	NOTE: The Enphase IQ System Controller is intended to operate with an Internet connection through the IQ Gateway. Failure to maintain an Internet connection may have an impact on the warranty. See Limited Warranty for full terms and services (enphase.com/warranty).
	NOTE: When replacing an Enphase IQ System Controller, you must replace it with an IQ System Controller of the same type, with the same AC current rating.
	NOTE: Properly mount the IQ System Controller. Ensure that the mounting location is structurally suited to bearing the weight of the IQ System Controller.
	NOTE: During use, storage, and transport, keep the IQ System Controller: <ul style="list-style-type: none"> • Properly ventilated • Away from water, other liquids, heat, sparks, and direct sunlight • Away from excessive dust, corrosive and explosive gases, and oil smoke • Away from direct exposure to gas exhaust, such as from motor vehicles • Away from falling or moving objects, including motor vehicles. If mounted in the path of a motor vehicle, we recommend a 91cm (36-inch) minimum mounting height • In a location compliant with fire safety regulations • In a location compliant with local building codes and standards
1	NOTE: IQ System Controller is not suitable for use as service equipment in Canada.



Environmental Protection

ELECTRONIC DEVICE: DO NOT THROW AWAY. Waste electrical products should not be disposed of with household waste. Refer to your local codes for disposal requirements.