

Envoy Communications Gateway



Corporate Headquarters Contact Information

Enphase Energy Inc.
1420 N. McDowell Blvd.
Petaluma, CA 94954
USA
Phone: +1 707-763-4784

<http://www.enphase.com/support>
info@enphaseenergy.com



Other Information

For third-party license information, refer to www.enphase.com/licenses.

For Enphase patent information, refer to <http://enphase.com/company/patents/>.

Product information is subject to change without notice. All trademarks are recognised as the property of their respective owners.

For warranty text, refer to <http://www.enphase.com/warranty>.

User documentation is updated frequently; Check the Enphase website (<http://www.enphase.com/support>) for the latest information.

Copyright © 2014 Enphase Energy Inc. All rights reserved.

Table of Contents

Important Information.....	5
Read this First	5
Safety Instructions	5
Audience.....	5
The Enphase Envoy Communications Gateway	6
Other Elements in the Enphase System.....	7
How the Envoy Communications Gateway Works.....	7
Installation Planning and Preparation.....	8
System Sizing.....	8
Preinstallation Checks	8
Installation Sequence	9
Install the Envoy	10
1. Find the Envoy Serial Number	10
2. Register the Envoy	11
3. Find a Location for the Envoy	12
4. Connect to the Internet	12
Method A: Ethernet Cable	13
Method B: Power Line Communication Bridges	13
Method C: Enphase Wireless Adapter (Wi-Fi).....	13
5. Select Language.....	14
6. Check the Internet Connection	15
7. Install the Modules and Microinverters	15
8. Check the Envoy's Progress.....	15
9. Wall Mount the Envoy (Optional)	16
10. Build the Virtual Array	17
11. View System Performance in Enlighten.....	17
Envoy Operation	18
First Scan for Microinverters.....	18
LCD Screen Display at Initial Start Up	19
Initial Communications Check	19
Subsequent Start Up	19
Normal Operation	20
Using the Envoy LCD Menu	20
Initiating a Scan for New Microinverters	22
Performing a Communications Check	22
Viewing the Grid Configuration.....	24
Getting a New IP Address	25
Enabling a Connection to Enphase	25
Disabling a Connection to Enphase	26
Viewing the Envoy Serial Number	26
Selecting a New Locale (Change Language Display)	27
How the Envoy Works with Enlighten	27
Using Enlighten to Check Envoy Status	28
Troubleshooting	29
Power Line Communication Troubleshooting	29
Issue: The Microinverter Count is Lower than the Number of Installed Units	29
Issue: Envoy Displays Fewer than Three Bars.....	29
Issue: Envoy Displays Zero Bars.....	30
Network Basics and Troubleshooting	30
Issue: IP Address Problems	31
Issue: LCD Screen Displays "-Web"	31
Issue: LCD Screen Displays "Envoy Failure +Web or -Web"	31
Issue: LCD Screen Displays "Scanning Inhibited"	31
Issue: The Envoy has Good Signal Strength but is Too Far from the Router	32
Issue: Wireless Adapter Wi-Fi Problems	32
Issue: How Set Up Wi-Fi Without Wi-Fi WPS.....	32
Issue: Internet Traffic is Slower After Installing a Bridge	33
DHCP versus Static IP Addressing	34
MAC Filtering.....	34
Firewall Settings	35
Replacing an Envoy.....	35
Envoy Local Interface	36
Connecting to the Envoy through the Site's LAN.....	36
Directly Connecting to the Envoy without a Broadband Router	36

Home Screen.....	37
Events Screen	37
Production Screen	38
Inventory Screen.....	38
Administration Screen.....	39
Administration Screen Tasks	39
Set or Change the Grid Profile	40
Set Up Device Scan Control.....	44
Set the Time Zone (optional).....	45
Other Administration Tasks	45
Event Messages	46
Technical Data	52

Important Information

Read this First

- Follow the instructions in this manual. These instructions are key to the installation and maintenance of the Enphase Envoy® Communications Gateway (Envoy).
- To ensure the safe installation and operation of the Envoy, note the following safety symbols that appear throughout this document to indicate dangerous conditions and important safety instructions.



WARNING! This indicates a situation where failure to follow instructions may be a safety hazard or cause equipment malfunction. Use extreme caution and follow instructions carefully.



NOTE: This indicates information that is very important for optimal system operation. Follow instructions closely.

Safety Instructions

- Perform all electrical installations in accordance with all local electrical standards.
- Do not attempt to repair the Envoy; it contains no user-serviceable parts. Tampering with or opening the Envoy will void the warranty. If the Envoy fails, contact Enphase Customer Support for assistance at <http://www.enphase.com/support>.
- Warranty void if cover removed.
- Refer servicing to qualified personnel.
- The Envoy is required for each installation to configure the Grid Profile on the microinverters. You must configure the Grid Profile before the microinverters can export power.
- Before installing or using the Envoy, read all instructions and cautionary markings in the technical description and on the Envoy.

Audience

This manual is intended for use by professional installation and maintenance personnel.

The Enphase Envoy Communications Gateway

The Envoy® Communications Gateway is an integral component of the Enphase® Microinverter System™. It operates between the Enphase Microinverters and the Enphase Enlighten® web-based monitoring and analysis software. The Envoy functions as a gateway and monitors the microinverters that are connected to the PV modules. The Envoy collects energy and performance data from the microinverters over on-site AC power lines. It then forwards that data to Enlighten, via the Internet, for statistical reporting.

The three key elements of an Enphase system are the:

- Enphase Microinverter
- Enphase Envoy Communications Gateway
- Enphase Enlighten web-based monitoring and analysis software

This integrated system maximises energy harvest, increases system reliability, and simplifies design, installation and management. The following diagram shows the Envoy in the system.



- 1 Enphase Microinverters**
 - are installed beneath each solar module
 - maximise energy harvest
 - send AC power over AC wiring to the AC mains
 - also send performance data via the AC wiring
- 2 Envoy Communications Gateway**
 - plugs into an AC outlet
 - collects information via the AC wiring
 - transmits data through a standard broadband router to the Internet
 - collects information and transmits it to Enlighten
- 3 Enphase Enlighten Monitoring**
 - provides monitoring and analysis
 - allows performance data to be viewed from any web browser

Other Elements in the Enphase System

The Enphase Microinverter converts the DC output of the PV module into grid-compliant AC power. In addition to performing the DC to AC conversion, it maximises energy production by using a sophisticated Maximum Power Point Tracking (MPPT) algorithm. This integrated system maximises energy harvest, increases system reliability, and simplifies design, installation and management.

The Enphase Enlighten web-based monitoring and analysis software analyzes the data collected by each communicating microinverter. Enlighten automatically detects any shortfall in energy production, identifies possible causes, and suggests solutions. Enlighten constantly monitors every Enphase Microinverter connected to the Envoy and is essential for monitoring and troubleshooting.

How the Envoy Communications Gateway Works

Installation and operation of the Envoy require no specialised equipment or unique computer or networking expertise. To the Local Area Network (LAN), the Envoy is just another host on the network, much like a personal computer. The Envoy simply connects to the on-site router for communications with the Enphase Enlighten monitoring and analysis website. The Envoy communicates with the individual microinverters using the existing power lines in the residence or business.



IMPORTANT! The Envoy is required for each installation. It provides monitoring and allows you to configure the Grid Profile on the microinverters. You must configure the Grid Profile before the microinverters can export power.

After the Envoy is installed and completes its initial scan, it maintains an internal database of all known Enphase Microinverters at the site it manages. At regular intervals, the Envoy polls each microinverter for its energy data. Using the site's broadband router, the Envoy then forwards that information to Enlighten. The Envoy also reports any error conditions that affect it or the microinverters. You can view both energy data and error conditions in Enlighten.

The Envoy incorporates power line and Internet communications functions. As shown in the diagram, one "side" of the Envoy communicates with the microinverters through power lines at the site. The other "side" of the Envoy communicates with the Internet using a standard Ethernet/network cable plugged into the broadband router.

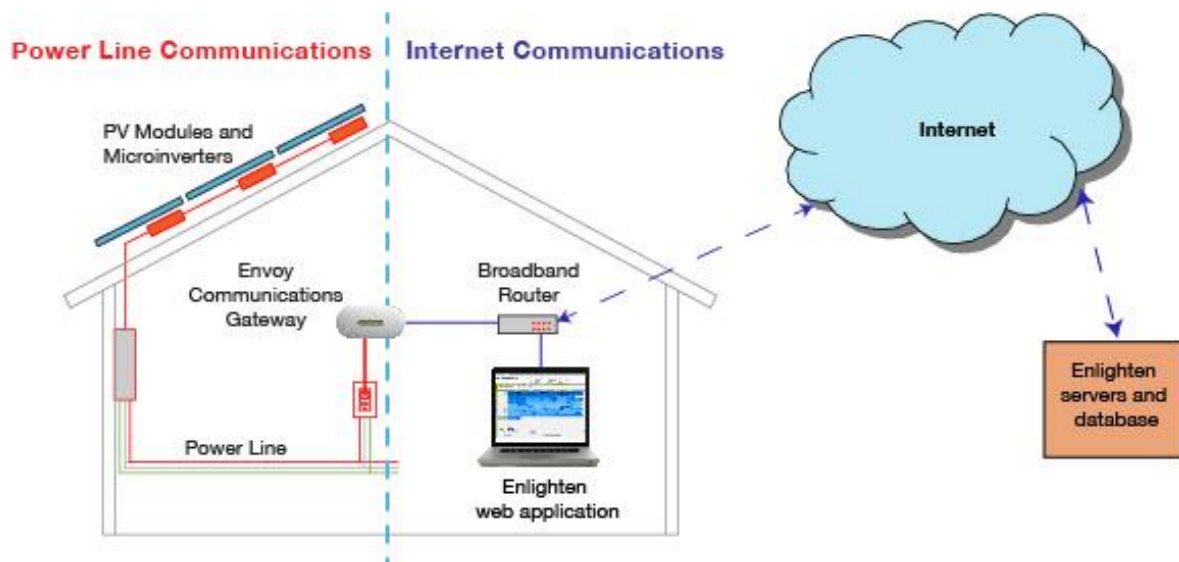

Installation Planning and Preparation

Review the following preinstallation checks before you install the Envoy.

System Sizing

The Envoy is capable of monitoring up to 600 Enphase Microinverters.

Preinstallation Checks

1. Before installing the Envoy, make sure that the site meets the following minimum requirements:
 - Standard AC outlet is available near the AC mains. Do not use a power strip.
 - Laptop or other computer is available for set up
2. To use the Enlighten web-based monitoring and analysis software, additional requirements are:
 - Always-on broadband Internet connection
 - Broadband router with spare Ethernet port or a wireless router if using the optional Enphase wireless adapter.
 - Up-to-date web browser to view Enlighten. Supported browsers are Internet Explorer 8 or higher, Firefox 11 or higher, Chrome 5 or higher, and Safari 5 or higher. Enlighten requires Adobe Flash Player 10 or higher. For Internet Explorer 8 users, install the Google Chrome Frame plug-in. Enlighten is compatible with Internet-enabled mobile devices running iOS 5 or higher and Android 4 or higher.
3. If you are installing the Envoy (ENV-230) in a three-phase application, the power line communication signal must be “coupled” between the three phases to allow the Envoy to communicate with all of the microinverters in the system. Install a phase coupler (Enphase number LPC-01), or wire a capacitor into the system. With either solution, install the device on the load side of the over-current protection device. See the Enphase Technical Brief on Phase Coupling for your region at <http://www.enphase.com/support>.
4. Check the Envoy shipping box for the following items:
 - Envoy Communications Gateway
 - Ethernet cable
 - AC power cord
 - *Envoy Communications Gateway Quick Install Guide*
5. If you plan to wall-mount the Envoy, you need two #8 (4.166 mm diameter) screws and a screwdriver.

Installation Sequence

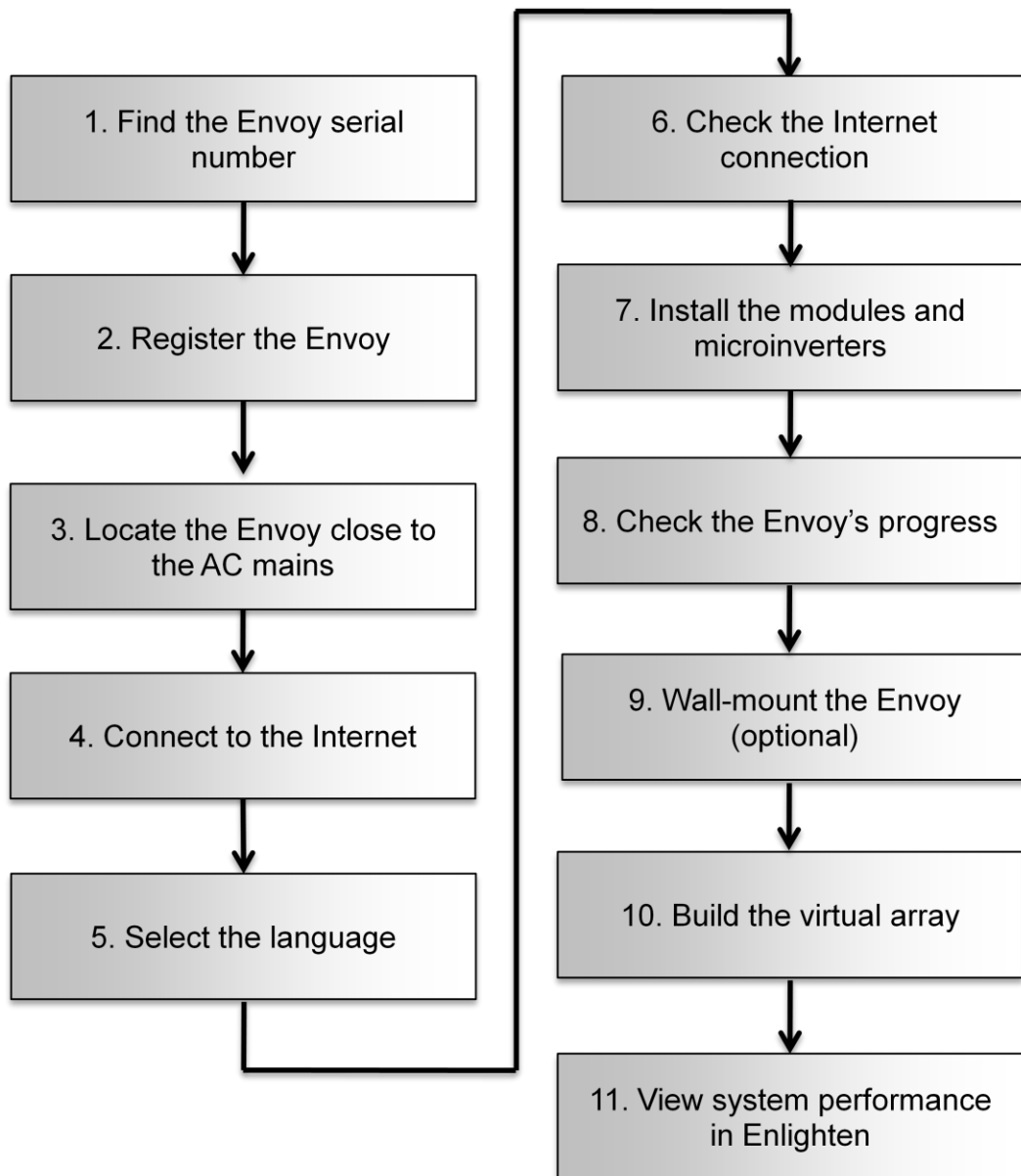

Install the Envoy

To install the Envoy, perform the following steps.



BEST PRACTICE: When powered up and connected for the first time, the Envoy may retrieve an automatic upgrade from Enphase. Because this upgrade may take up to 15 minutes, connect the Envoy first at the site (connect to both AC power and the broadband router) so that it performs the upgrade well before the solar module installation is complete.



WARNING! Do not remove power from the Envoy if the LCD displays: “Upgrading. . . Do Not Unplug.”

1. Find the Envoy Serial Number

The serial number label is on the back of the Envoy, near the left mounting bracket. You can build the system map manually, by peeling the serial number label from the Envoy and placing the label on the installation map, or you can use the Enphase Installer Toolkit to easily build and configure a system. Refer to <http://enphase.com/installer-toolkit/> for more information.

To manually build the installation map:

- a. Remove the Envoy’s removable serial number label.
- b. Attach the serial number label to the microinverter installation map, or make note of it for registration in the next step.

If needed, you can find an installation map at the back of the Enphase Microinverter manual.

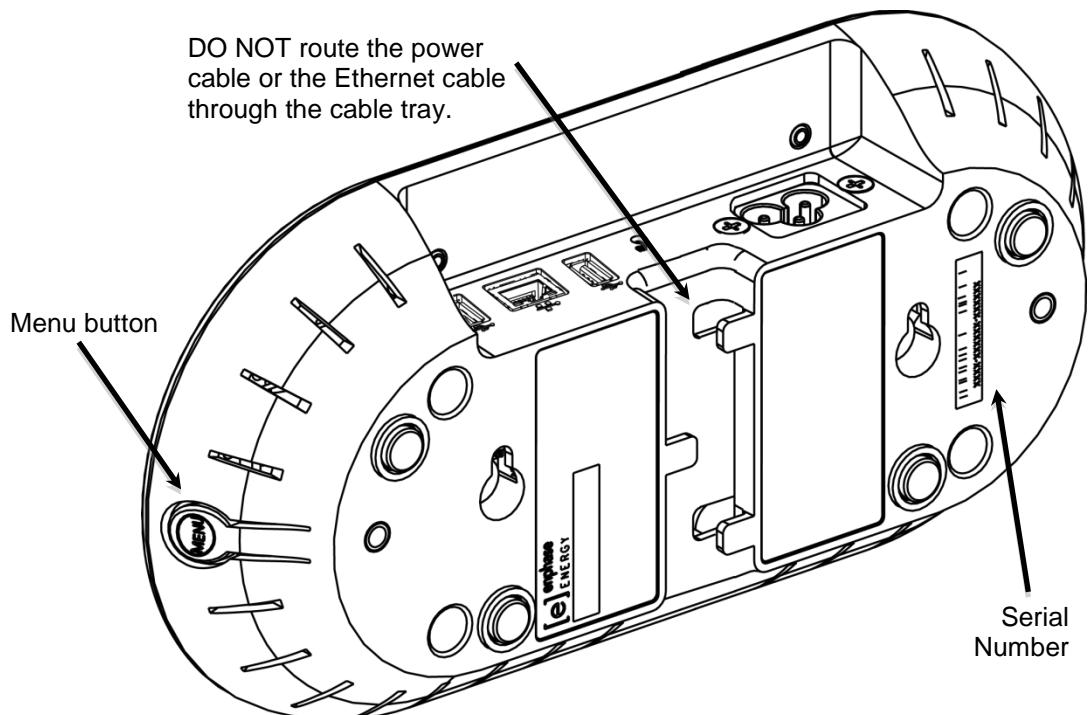

2. Register the Envoy

Register the Envoy at the beginning of the PV installation.

- a. Use your previously issued username and password to log in to in Enlighten. If you haven't registered, go to www.enphase.com and click **Enlighten Login**.
- b. At the installer dashboard, click **Add a New System**. If you have already registered the site, find the system under **Installations in Progress**.
- c. Under **System**, enter the system Name, Type and Installer Reference (optional).
- d. Enter **Installer** information.
- e. Under **Owner**, enter the Name, Email, and Phone.
- f. Under **Location**, enter the Country and address information.
- g. Under **Envoy**, select the Internet Connection type, enter the Envoy Serial Number, and **select a Grid Profile**.



NOTE: For more information on Grid Profiles, see “Set or Change the Grid Profile” on page 40.



NOTE: If you need to change the grid profile subsequent to this initial procedure, follow the steps in “Set or Change the Grid Profile” on page 40.



NOTE: Enphase Microinverters will not begin exporting power until the Envoy Communications Gateway is installed and has detected all of the microinverters at the site. In addition, the grid profile must be configured and the Envoy must have propagated these settings to the microinverters.

The screenshot shows a web form for registering a new system. The form is divided into several sections:

- System:** Includes fields for *Name, Installer Reference, *Type (with a dropdown menu set to 'Residential'), and a checkbox for 'Third Party Owned (ex: PPA or Leased)'.
- Installer:** Includes a dropdown menu for the installer, currently set to 'Enphase Energy'.
- Owner:** Includes fields for First Name, Last Name, Email, and Phone. Below these is a note: 'Owner will receive MyEnlighten for system performance monitoring.' with a link 'Change Enlighten Version'.
- Location:** Includes fields for Country (dropdown set to 'Belgium'), Street Address, Street Address 2, City, State/Province (dropdown set to 'None'), and Zip/Postal Code.
- Envoy:** Includes a dropdown for *Internet Connection (set to 'Select one'), a field for Envoy Serial Number, and a dropdown for Grid Profile. The Grid Profile dropdown is open, showing options 'Select one', 'C10_11', and 'C10_11 20130101'.
- Modules:** Includes a field for *Total Number of PV Modules (Panels) and a dropdown for PV Module (set to 'Select a Manufacturer').
- Installation:** Includes a dropdown for Microinverter Attachment Type (set to 'Select one') and a dropdown for Array Type (set to 'Select one').

- h. Under **Modules**, enter total number of modules, type, etc.
- i. Under **Installation**, select the Attachment and Array Type.
- j. Click **Save** to submit the form. You will receive a confirmation message: “Activation Created Successfully.”

3. Find a Location for the Envoy

Place the Envoy as close to the AC mains as possible. This ensures that the Envoy receives the strongest possible communications signal from each microinverter. Place the Envoy indoors or in an environmentally protected location. For wall mounting instructions, see “**Wall Mounting**” on page 16.



NOTE: If you are installing the Envoy (ENV-230) in a three-phase application, the power line communication signal must be “coupled” between the three phases to allow the Envoy to communicate with all of the microinverters in the system. Install a phase coupler (Enphase number LPC-01), or wire a capacitor into the system. With either solution, install the device on the load side of the over-current protection device. See the Enphase Technical Brief on Phase Coupling for your region at <http://www.enphase.com/support>.

- a. Locate an indoor AC outlet **close to the AC mains**.
- b. Place the Envoy so that its AC cord can reach this outlet.
- c. Plug the AC power cord into the AC input on the Envoy.
- d. Plug the other end of the power cord into a dedicated AC outlet (not a power strip).



WARNING! When an Envoy is plugged in and powered up for the first time, it is important to allow the database initialization process to complete in its entirety, without unplugging or removing power. This does not apply during subsequent power-downs, even if power is removed during the boot process.

As an alternative if signal strength is poor, power the Envoy from the solar production circuit (where local electrical code allows for monitoring equipment on the same circuit). This provides the best possible power line communications. Remember that you must locate the Envoy indoors (a garage, attic, basement, or other cool, dry location) or in an outdoor weatherproof enclosure. Remember also to allow for Ethernet access.



WARNING! Do **not** plug the Envoy into a power strip, surge protector, or uninterruptable power supply (UPS). The surge suppression or filtering within these devices impede power line communication performance. Also, if possible, do not plug a power strip into the same outlet that the Envoy is using. The surge suppression or filtering components of a power strip may still interfere with communications if they are near the Envoy.

4. Connect to the Internet

The Envoy requires a connection to the Internet, usually through an existing broadband router or other access point at the installation site. To accomplish this connection, many customers use the included CAT5 Ethernet cable. However, if using this cable is not possible, Enphase offers two other solutions. You can purchase either of these solutions separately:

- Power line communications bridge pair: Order EPLC-02 (EU), EPLC-03 (UK) or EPLC-04 (AU).
- Wireless adapter (also known as a “Wi-Fi USB stick”). Order WF-01.

Connect to a broadband router using one of these three methods, described in the following sections:

- Ethernet Cable
- Enphase Power Line Communication Bridges
- Enphase Wireless Adapter (Wi-Fi)

When using the Ethernet cable, two small LEDs on the Ethernet port indicate Internet link and activity. One LED will be solid green, and the other will blink green or yellow every few seconds.

Method A: Ethernet Cable

- a. Plug the Ethernet cable into the Ethernet port on the Envoy.
- b. Plug the other end of the cable into a spare port on the broadband router.

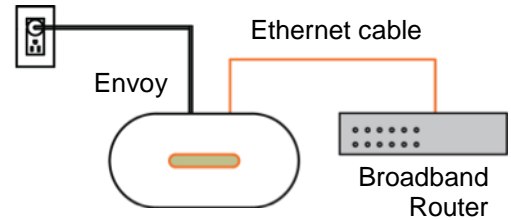

WARNING! Do not remove power from the Envoy if the LCD displays: **“Upgrading. . . Do Not Unplug.”**

Method B: Power Line Communication Bridges

Order EPLC-02 (EU), EPLC-03 (UK) or EPLC-04 (AU) separately.

If you need to locate the Envoy away from the router, at a distance where an Ethernet cable is not practical, use power line communication bridges with the Envoy or purchase a wireless Ethernet bridge. Bridges allow the Envoy to communicate with the broadband router without the need for additional Ethernet cabling. To install the power line communication bridges:



WARNING! Do not remove power from the Envoy if the LCD displays: **“Upgrading. . . Do Not Unplug.”**

- a. Plug one of the bridges into the same AC outlet that the Envoy is using.
- b. Connect one end of the Ethernet cable to the Ethernet port on the Envoy.
- c. Connect the other end of that Ethernet cable to the bridge.
- d. Plug the other bridge to an AC outlet near the broadband router.
- e. Connect one end of a second Ethernet cable to the second bridge.
- f. Connect the other end of the Ethernet cable into the broadband router.
- g. If the broadband router is operational, press and hold the Envoy menu button. Release the button when the LCD displays Get New IP Address. Wait for 5 minutes. If this fails, unplug the Envoy, wait for 15 seconds, and plug it back in. Wait 5 minutes for connection.

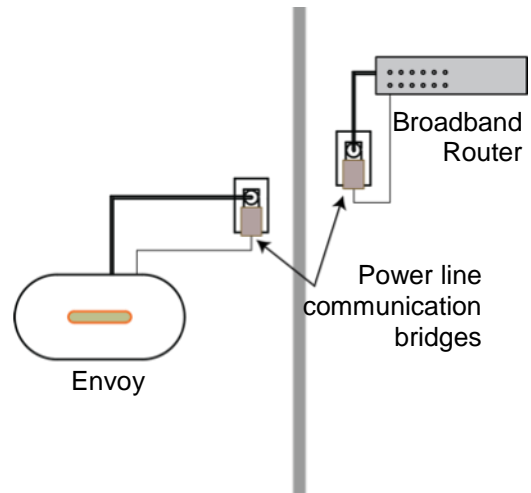

Method C: Enphase Wireless Adapter (Wi-Fi)

Order WF-01 separately.

To use the Enphase wireless adapter, you need a wireless router. To install the wireless adapter, do the following:



NOTE: If using a wireless adapter, you must use the Enphase-provided wireless adapter, and the router or access point must support wireless connections (Wi-Fi). Other wireless adapters may not operate correctly and are not supported by Enphase.

- a. On the Envoy, verify that no Ethernet cable is plugged into the Envoy RJ45 port.
- b. Verify that the wireless router you are connecting to supports Wi-Fi WPS. On the router, look for a button labelled “WPS”. If

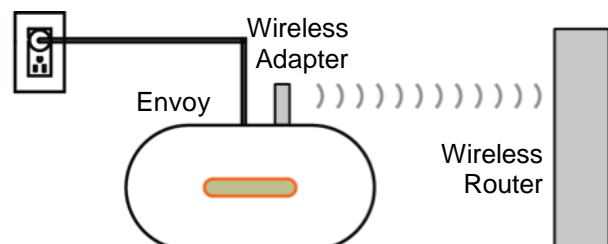

the router does not support Wi-Fi WPS, see “Issue: How Set Up Wi-Fi Without Wi-Fi WPS” on page 32.

- c. Verify that the start-up message on the LCD screen reads "R3.8" or later.
- If it does not, upgrade the Envoy by connecting the Envoy Ethernet port to the broadband router with the Ethernet cable that came with the Envoy.



WARNING! Do not remove power from the Envoy if the LCD displays: “Upgrading. . . Do Not Unplug.”

- After the upgrade completes, **unplug the Ethernet cable from the Envoy.**
- d. Once you have verified that the Envoy is running release R3.8 (or later), plug the wireless adapter into the left USB port (looking at Envoy from the front), and wait for 10 seconds.
- e. Press and hold the WPS button on the wireless router (or access point) for two seconds. On many routers, the WPS button flashes at this point.
- f. Within two minutes, return to the Envoy. Press and hold the Envoy menu button until the Envoy Menu appears. Release the Envoy menu button when Enable Wi-Fi WPS appears on the LCD screen.
- g. Within two minutes an updated IP address appears on the Envoy LCD screen. This IP address begins with a “W” to indicate that a wireless connection is established.
- h. If the updated IP address does not appear, retry the previous steps as the connection window may have timed out.
- i. Within a minute, the Envoy LCD screen displays **+Web**, indicating a successful connection to Enphase.



NOTE: The operating temperature range for the Enphase-provided wireless adapter is 0°C to 40°C (32°F to 104°F).



NOTE: If the wireless router does not support WPS or you aren't using WPS for Wi-Fi setup, see “Network Basics and Troubleshooting” on page 30.

5. Select Language

After the Envoy starts up it will request that you set the Language.

The Envoy LCD panel will scroll through the available language settings and will continue to scroll until you make a selection.

- When you see the setting you need, press the Menu button and hold it down for two seconds

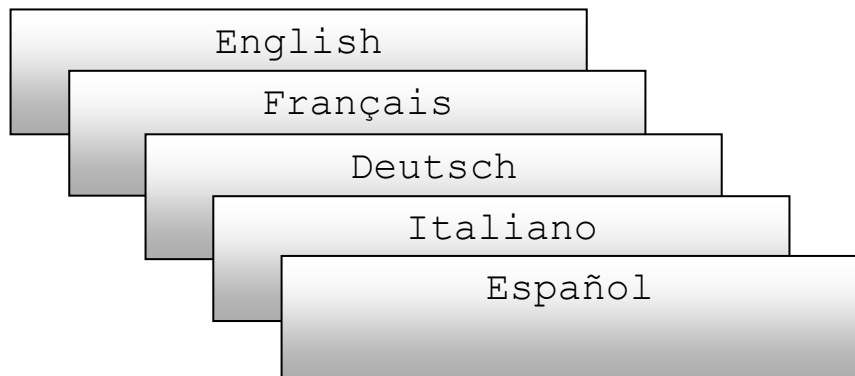

6. Check the Internet Connection

- a. Look for the “+Web” indication.
- b. If it still shows “-Web” five minutes after connecting to the broadband router, see “Network Basics and Troubleshooting” on page 30.



NOTE: Power production shows as 0W and 0kWh until the microinverters are discovered, the Envoy has reported to Enlighten, and monitoring begins. Power production also shows 0W and 0kWh for about a minute whenever the Envoy powers up.

192.168.2.140	+Web
0W	0kWh
	0

7. Install the Modules and Microinverters

- a. Install the PV modules and the microinverters as directed by the installation manuals.
- b. Use the Installer Toolkit to scan the microinverters. For more information, go to <http://enphase.com/installer-toolkit/>.
- c. As an alternative, you can manually build the map: peel the removable serial number label from each microinverter and affix it to the respective location on the map.

8. Check the Envoy’s Progress

- a. Check the device count (shown as “2” in the illustration). An automatic device scan will detect microinverters when the DC and AC connections are completed and the AC circuit is energised. If the device scan isn’t running, start a new one:

- Press and hold the Envoy menu button (on the right side of the Envoy).
- Release the button when the LCD window displays **Enable Device Scan**.

Level:	[≡≡≡]
Devices:	2

- b. Check the power line communications. The number of “Level” bars on the Envoy LCD Level/Devices screen should be three or more. (The illustration shows three bars.) If there are fewer than three bars, see “Power Line Communication Troubleshooting” on page 29. If the communication check isn’t running, start a new one:

- Press and hold the Envoy menu button (on the right side of the Envoy).
- Release the button when the LCD window displays **Enable Communication Check**.



NOTE: The Envoy may display “Priority Scan is Active” on the LCD screen during the device scan.

- c. Check that the Envoy LCD shows a complete device count after about 20 minutes. If it does not, see “Power Line Communication Troubleshooting” on page 29.
- d. Check that all microinverters are discovered. As soon as all microinverters at the site have been discovered, use the Envoy Device Scan Control menu to stop the device scan:
 - Press and hold the Envoy menu button (on the right side of the Envoy).
 - Release the button when the LCD window displays **Disable Device Scan**.



NOTE: The number of devices shown in the Device Scan screen may not match the number of devices shown on the Home screen until the device scan is complete.



NOTE: For sites with neighbouring Enphase systems, do not allow a device scan to run overnight because it may discover neighbouring microinverters when they first power-up in the morning. Always stop the device scan in the afternoon, before leaving the site.

- e. Refer to “LCD Screen Display” on page 19 for more information.

9. Wall Mount the Envoy (Optional)



NOTE: Before mounting the Envoy, it is best to perform a Communications check, as described on page 22, to find the best location for your Envoy.

After you have positioned your Envoy for optimal communications and after it has detected all devices, you can mount the Envoy on a wall. To do this:

- a. Use two drywall screws or wall anchors (not included) to affix the Envoy to the wall, mounted at the dimensions shown. You will need two #8 screws (4.17 mm or 0.16 in. diameter); maximum screw head diameter is 8.9mm (0.35 in.).
- b. Slide the Envoy onto the mounting screws, aligning the Envoy screw holes with the screws installed in step a.

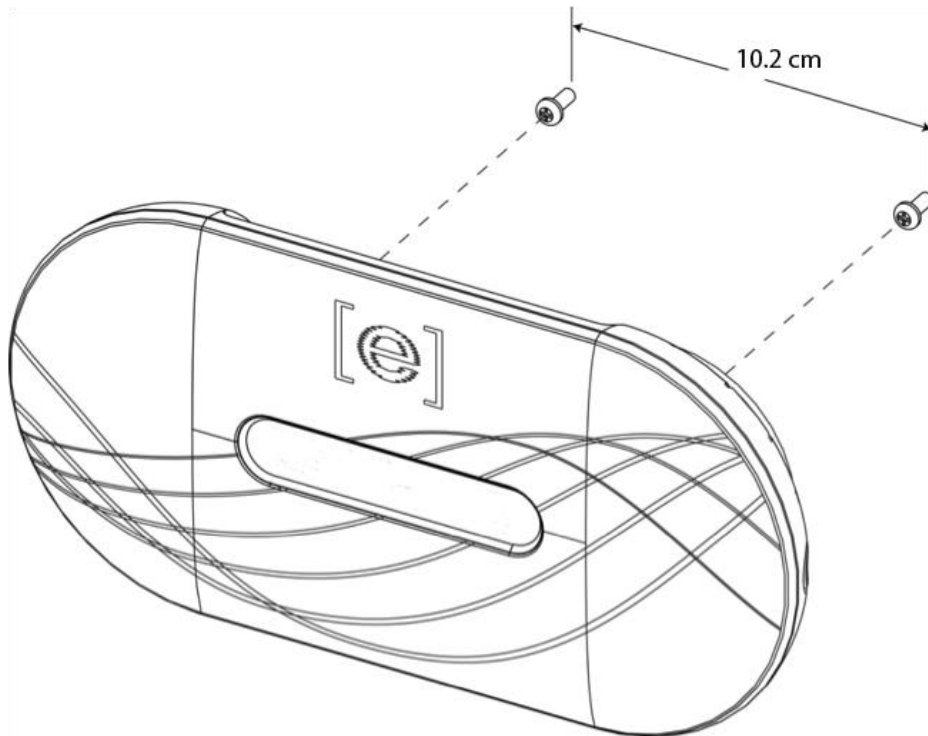

NOTE: DO NOT route the power cable or the Ethernet cable through the cable tray on the rear of the Envoy.

10. Build the Virtual Array

When the system is energised and the Envoy detects at least one microinverter, create the virtual array in Enlighten from the installation map you created.

You can scan and upload the paper copy of the Installation Map, or you can use the Enphase Installer Toolkit to easily build and configure a system. Refer to <http://enphase.com/installer-toolkit/> for more information.



To build the virtual array manually:

- a. Log in to Enlighten.
- b. Use Array Builder to create the virtual array in Enlighten.
- c. Use your installation map as your reference.

To see the Array Builder demo, go to <http://enphase.com/support/videos/>.

Add Array

1 Choose orientation of modules within array

 
i You can mix the orientation of modules and rotate them in a moment.

2 Rough shape rows x columns = 9 modules

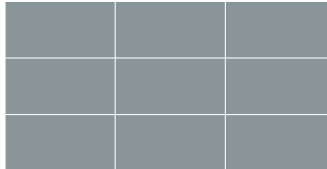
i Once the array is created you can add, subtract and move modules easily to create an accurate plan.

3 Azimuth ° i Azimuth is the difference, measured in 0-359 degrees, from true North.

4 Array name

Once the virtual array is built, Enlighten displays a graphic representation of the PV system. It also shows detailed current and historical performance information.

11. View System Performance in Enlighten

Once the array is built and the system is activated, you can log in to Enlighten to view site data.

- a. If you have not done so already, log in to Enlighten to view system data.
- b. Refer to “How the Envoy Works with Enlighten” on page 27 for more information.

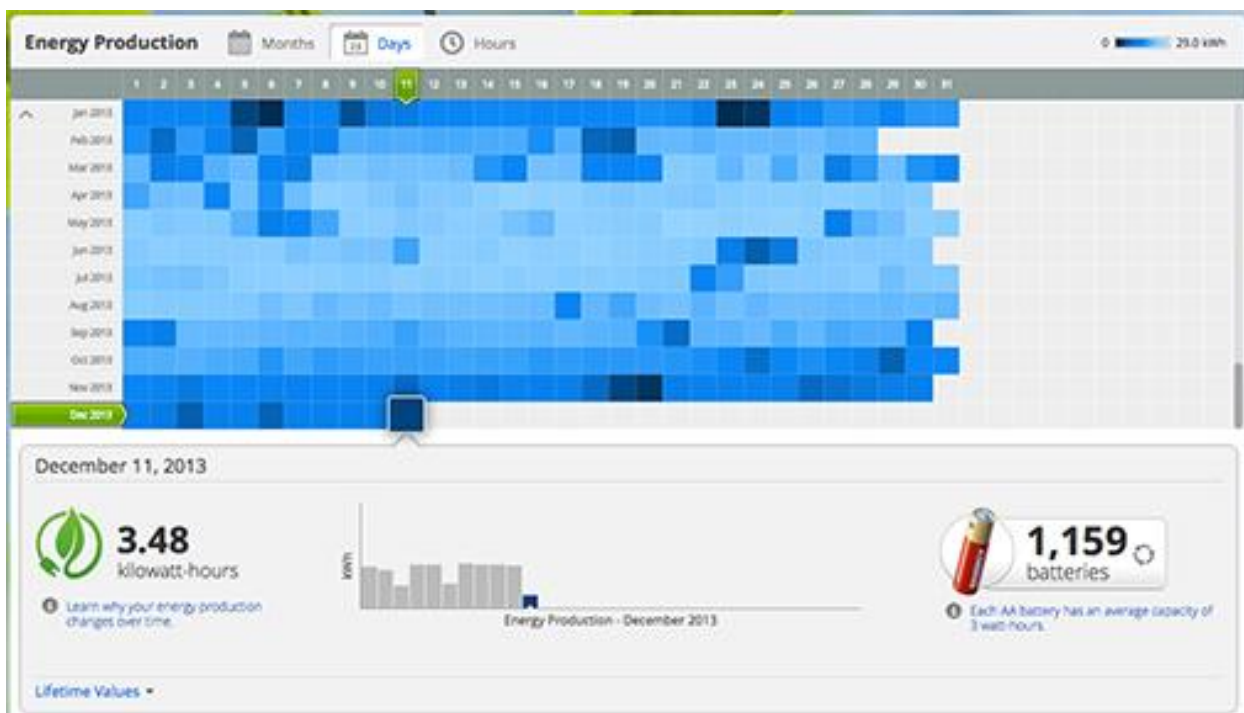

Envoy Operation

First Scan for Microinverters

A newly installed Envoy automatically performs an initial scan to discover all of the microinverters that are installed and powered up at the site. This initial scan continues to search for new microinverters for eight hours from initial start up of the Envoy. This one-time scan is not repeated automatically. During the scan, you will notice some values increasing on the Envoy display.



NOTE: If the eight-hour scan expires before installation of microinverters is complete, you must initiate a new scan. To start a new device scan, see page 22 of this manual.



NOTE: If the Envoy was not factory built with software release 3.2, the initial scan will run for seven days. With release 3.2, the initial scan time was reduced from seven days to eight hours. If the Envoy upgrades to release 3.2 after an initial scan has begun, the initial scan duration remains at seven days.



WARNING: Stop the scan once all of the devices are detected (see page 15). For sites with neighbouring Enphase systems, do not allow the device scan to run overnight because it may discover neighbouring microinverters when they first power-up in the morning.

The Envoy identifies each device by its unique serial number. If a microinverter is added or replaced at the site, you must initiate a new scan so that the Envoy can discover the new microinverter. To start a new device scan, see page 22 of this manual.

After the Envoy has detected at least one new device, it automatically enters Priority Scan mode. The LCD screen displays the following, where “nnnn” represents the number of microinverters (devices) detected.

```
Priority Scan is  
Active.   Devs: nnnn
```

When the Envoy does not detect a new device during a polling interval (usually five minutes), it exits Priority Scan mode. If, subsequently, the Envoy detects another new device, it returns to Priority Scan mode. It remains in this mode until it again completes an interval where no new devices are detected.

LCD Screen Display at Initial Start Up

When the Envoy starts up for the first time, it goes through the initial boot sequence. During this initial boot sequence, the Envoy LCD screen displays start-up progress as shown:

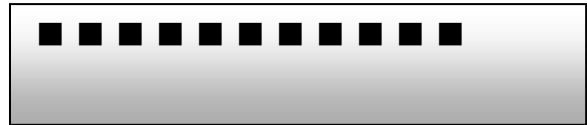

Initial Communications Check

The last two screens in the initial sequence alternate until the Communications Check ends, after 20 minutes. The Envoy normally displays "-Web" for two to three minutes after the first start up. It then sends the first report to Enlighten. When Enlighten responds, the Envoy displays "+Web".

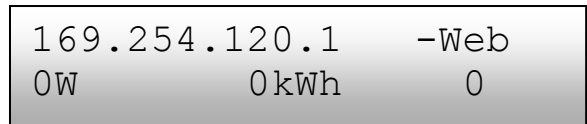
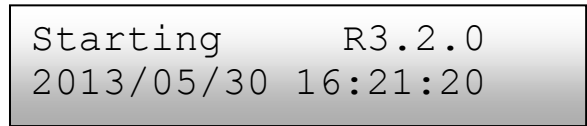

Subsequent Start Up

After a power outage or Envoy shut down, the Envoy is ready to work just five minutes after reapplying power. You will know the Envoy has completed booting and has started normal operation when it displays both an IP address and the "+Web" status indication in the LCD screen. The normal, post-installation boot sequence is similar to the initial start up, although the "Initializing Data" screen is not repeated.

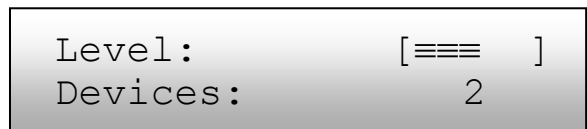
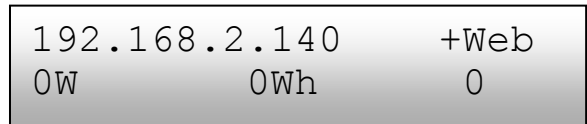

Normal Operation

Once the Envoy completes a scan, normal operation begins or resumes. At this point, the indicators in the LCD screen show current values for your system. This is the home screen:

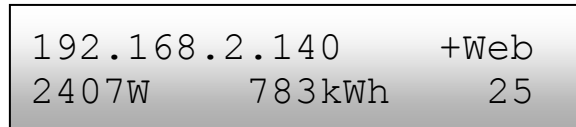

It may be a few minutes before energy data appears or increases on the home screen after starting up the Envoy or initiating a scan. Information shown during normal operation includes:

- Local IP address, for example: **192.168.2.140** (your actual local IP address will be different). The Envoy attempts to get a dynamically assigned DHCP (Dynamic Host Configuration Protocol) IP address during power-up sequence. The Envoy uses the DHCP IP address as a route to the Internet. If 169.254.120.1 is shown, the Envoy has not yet acquired a dynamic IP. Refer to "Troubleshooting" on page 29, if this address continues to display.
- Web connection indication: **+Web**. The web status indicates whether the Envoy is connected to Enlighten. The status **-Web** indicates that the Envoy is not connected to Enlighten.
- Indication of the present power-production, in watts: **(n)W** (where n is a number)
- Indication of the life time kilowatt hours reported to this Envoy: **(n)kWh** (where n is a number)
- Indication of the number of online microinverters producing power, reporting in to the Envoy, and not having any error conditions: **(n)** (where n is a number). At night, the number of microinverters displayed is zero.

After the Envoy establishes an IP address and the web connection, the Envoy periodically contacts an NTP (Network Time Protocol) server to maintain an accurate local time.

Using the Envoy LCD Menu

Use the Envoy Menu button located on the right side of the Envoy to access the Envoy LCD menu.

1. Press and hold this button. After two seconds the Envoy menu appears in the Envoy's LCD screen.
2. Continue holding the Menu button. Menu items appear in the following order:

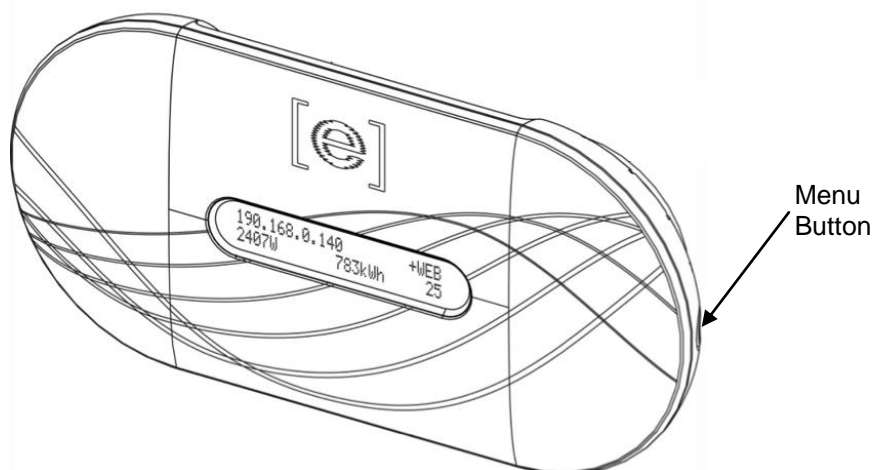

3. To select a menu item, release the Menu button when the desired menu item appears. The menu continues to cycle as long as you are pressing the Menu button. The **Exit Menu** option returns to the normal (default) display, usually the Home screen. See the following sections for detailed procedures.

Exit Menu

Enable
Device Scan

Disable
Device Scan

Enable
Communication Check

Disable
Communication Check

View Grid
Configuration

Get New IP Address

Enable Connection
To Enphase

Disable Connection
To Enphase

View Serial Number

Select New Locale

Initiating a Scan for New Microinverters

If you add additional microinverters to an existing system or replace a microinverter, you must run a scan to detect the new devices. To initiate a scan after you add new microinverters to an existing Enphase system, perform the following steps.

Alternatively, you can initiate a scan through the Administration page when connected to the Envoy local interface with a computer or via Enlighten (refer to “Using Enlighten to Check Envoy Status” on page 28).

1. Press and hold the Envoy Menu button. After two seconds the Envoy menu appears.
2. Continue holding the Menu button. When the LCD screen displays “Enable Device Scan”, release the Menu button.



Enable
Device Scan

The LCD screen then reads:



Device scan active
for 00**d**:00**h**:30**m**

The Envoy begins a 30-minute scan (if a longer scan is not already in progress) to identify all of the microinverters deployed at the site.

3. Log into Enlighten to check for the new microinverter, and use Array Builder to add the new microinverter to the virtual array.
4. After the microinverter is detected, it is best to disable the scan. To do this, press and hold the Envoy Menu button for two seconds to view the Envoy menu. When the LCD screen displays: “Disable Device Scan”, release the Menu button.



Disable
Device Scan

Performing a Communications Check

If you are unsure of where to place the Envoy for maximum performance, you can install the Envoy in various locations and check signal strength at each location. Normally, a communications check starts automatically after an Envoy restart. Alternatively, you can initiate a communications check with the Envoy Menu button or through the Administration page when connected to the Envoy local interface with a computer. You can also use Enlighten (see “Using Enlighten to Check Envoy Status” on page 28).



NOTE: Device scans and communications checks can only be done during daylight hours when the microinverters are active (that is, powered by the PV modules).

To use the Envoy Menu button to initiate a communications check:

1. Press and hold the Menu button on the right side of the Envoy to bring up the Envoy menu on the LCD screen.
2. When the LCD screen displays “Enable Communication Check”, release the Menu button.

Enable
Communication Check

The LCD screen then reads:

Comm check enabled
for 20min

The Envoy begins a 20-minute communications check to assess the signal strength between the Envoy and the microinverters detected at the site. Until the Envoy begins detecting microinverters, the display reads:

Communications check
Searching Devices



NOTE: The communications check displays communication levels for devices already in the Envoy database; it does not scan for new devices.

When the Envoy begins detecting microinverters, the display shows power line communication Level and Device count:

Level: [≡≡≡]
Devices: 2

To the right of the word “Level”, you’ll see brackets enclosing zero to five bars. The example above shows three bars.



NOTE: Until microinverters are detected, the Level indicator shows no bars.

Signal strength is acceptable if three to five bars are displayed and all devices are accounted for. One to two bars may not be sufficient for consistent communication.

3. If, after 15 minutes, fewer than three bars are displayed, refer to “Power Line Communication Troubleshooting” on page 29.

The “Devices” counter displays the number of microinverters detected and will increase until all microinverters are detected. Ultimately, the number of microinverters detected should match the number of installed microinverters.

4. After 20 minutes, the communications check stops. To stop the communications check before it times out, press and hold the menu button to activate the Envoy menu. When “Disable Communication Check” is displayed, release the menu button.

Viewing the Grid Configuration

To view the grid configuration (trip points profile) for the site, do the following.



NOTE: You cannot change the grid profile using this menu. To change this profile, and for more information on grid profiles, see “Set or Change the Grid Profile” on page 40.

1. Press and hold the Envoy Menu button. After two seconds the Envoy menu appears.
2. Continue holding the Menu button. When the LCD screen displays **View Grid Configuration**, release the Menu button.

View Grid
Configuration

The LCD screen then reads:

Gathering Grid
Configuration Data

If a grid profile **has not** been applied, the following screen is displayed. This indicates that the microinverters are not yet configured with a grid profile.

No Grid
Config. Applied

3. If needed, select a profile as described in “Set or Change the Grid Profile” on page 40.

If a grid profile **has** been applied, the following screens may be displayed.

4. Press the menu button at any time to exit this process.

(n) total devices

Number of microinverters detected.

(n) unsettable devices

Number of microinverters that **cannot** be set with a grid profile.

(n) devices are set
with (local spec)

Number of microinverters that are set with a grid profile and the name of the specification being used.

(n) are propagating
with (local spec)

Number of microinverters that are in the process of being set and the name of the specification being used.

(n) devices
have failed

Number of devices that failed to be set with a grid profile.

Checking grid config
Select to exit

Updating grid configuration data.

Getting a New IP Address

The Get New IP Address menu item makes the Envoy request a new IP address from the broadband router. To get a new IP address:

1. Press and hold the Envoy Menu button. After two seconds the Envoy menu appears.
2. Continue holding the Menu button. When the LCD screen displays “Get New IP Address”, release the Menu button.



Get New IP Address

The LCD screen now reads:



Getting IP Address

Once the new IP address has been requested, the LCD will return to the default display.

Enabling a Connection to Enphase

The Enable Connection to Enphase menu item creates a secure connection to Enphase allowing Enphase personnel to troubleshoot the system remotely.

To open a connection to Enphase:

1. Press and hold the Envoy Menu button. After two seconds the Envoy menu appears.
2. Continue holding the Menu button. When the LCD screen displays “Enable Connection to Enphase”, release the Menu button.



Enable Connection
To Enphase

The LCD screen now reads:



Enabling Connection

Once the connection is open, the LCD will return to the default display.

Disabling a Connection to Enphase

The Disable Connection to Enphase menu item closes the secure connection to Enphase.

To close a connection to Enphase:

1. Press and hold the Envoy Menu button. After two seconds the Envoy menu appears.
2. Continue holding the Menu button. When the LCD screen displays “Disable Connection to Enphase”, release the Menu button.



Disable Connection
To Enphase

The LCD screen now reads:



Disabling Connection

Once the connection is closed, the LCD will return to the default display.

Viewing the Envoy Serial Number

The View Serial Number menu item displays the serial number of the Envoy.

To view the serial number:

1. Press and hold the Envoy Menu button. After two seconds the Envoy menu appears.
2. Continue holding the Menu button. When the LCD screen displays “View Serial Number”, release the Menu button.

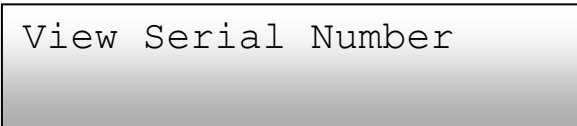

View Serial Number

The LCD screen now reads:

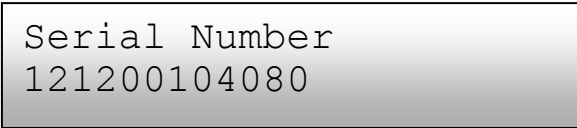

Serial Number
121200104080

Once the serial number has been displayed, the LCD will return to the default display.

Selecting a New Locale (Change Language Display)

You can set the LCD to display in English, French, German, Italian or Spanish. To do this:

1. Press and hold the Envoy Menu button. After two seconds you will enter the Envoy menu.
2. Continue holding the Menu button. When the LCD screen displays “Select New Locale”, release the Menu button.



Select New Locale

3. The Envoy LCD panel will scroll through the available locale settings. When you see the setting you need, press the Menu button and hold for two seconds.

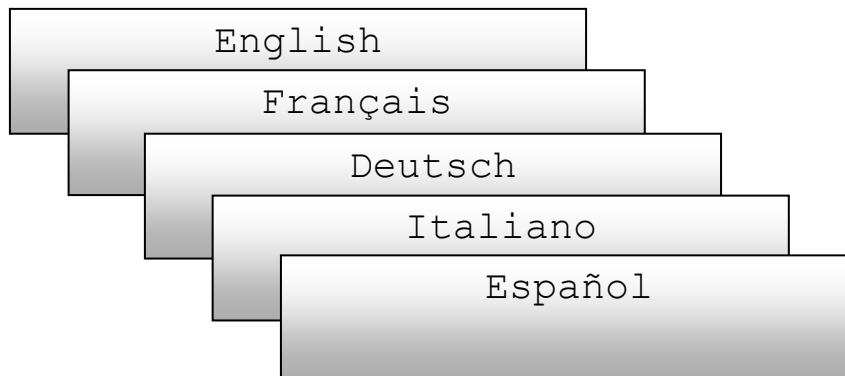

How the Envoy Works with Enlighten

The Envoy operates between the Enphase Microinverters and the Enphase Enlighten web-based monitoring software. The Envoy collects energy and performance data from the microinverters and forwards that data to Enlighten, via the Internet, for reporting.

Once you have registered the system and successfully installed the Envoy, Enlighten will set up an account for the site owner. You can then use Array Builder, a tool available to installers, to build the virtual array. Use the installation map you created during installation as a reference during this task. Or you can use the Enphase Installer Toolkit to easily build and configure a system. Refer to <http://enphase.com/installer-toolkit/> for more information.



NOTE: To see the Array Builder demo, go to <http://enphase.com/support/videos/>.

If you do not already have an account, go to <http://www.enphase.com> for more information.

When you complete the registration and installation, Enphase sends account information to the site owner so that they can log in to the Enlighten website and view system performance.

Enlighten provides a wide range of information on system performance. You can even access Enlighten on your mobile device and view current performance information wherever you are.

Using Enlighten to Check Envoy Status

To check status of Enphase equipment, do the following:

1. Log on to Enlighten to view the array. Click **Devices**.

A list of equipment appears including the Envoy(s) and all of the microinverters that the Envoy has detected. The column on the far right lists the status of each microinverter.

2. To view status information for the Envoy, click the Envoy serial number.

The screenshot displays the 'Web Communication' and 'Power Line Communication' sections. The 'Web Communication' section shows a '+Web' button and a last report timestamp of 'Thu August 08, 2013 01:06 PM HST'. The 'Power Line Communication' section shows a progress bar for '11 Inverters' with three bars indicating 'Detected 11/11', 'Communicating 11/11', and 'Producing power 11/11'. Below these sections is the 'Optional Tasks' area, which includes 'Check Signal Strength' and 'Rescan for Devices' buttons. Two orange callout boxes with arrows point to the 'Check Signal Strength' and 'Rescan for Devices' buttons, with text: 'Click here to Check Signal Strength' and 'Click here to Rescan for Devices or to Stop Device Scan'.

3. This screen indicates status for web communication, power line communication and microinverter count.
4. From here you can choose to **Check Signal Strength** or **Rescan for Devices** as needed. When checking signal strength, allow up to 15 minutes for a response.

Troubleshooting

The following sections describe possible problems and solutions. For information on system status and event messages, see “Event Messages” on page 46. For more extensive information, refer to the *Installer’s Guide to Troubleshooting an Enphase Installation* at <http://www.enphase.com/support>.



WARNING: Do not attempt to repair the Enphase Envoy; it contains no user-serviceable parts. Tampering with or opening the Envoy will void the warranty. If the Envoy fails, contact Enphase customer support to obtain an RMA (return merchandise authorization) number and start the replacement process.

Power Line Communication Troubleshooting

At power-up, the Envoy performs a “Communications check”. After a few minutes, it will display a number of bars in the LCD screen. This value, from zero to five, indicates the signal strength of the power line communication between the Envoy and the microinverters.



Any time the Envoy is restarted, it automatically performs a communications check. However, there may be times when you need to manually initiate a check. To do this:

- Press and hold the Envoy menu button. Release it when the LCD window displays **Enable Communication Check**. The check will run for 20 minutes.
- Note the number of bars shown in the Communications check.

A level of three to five bars is good. A number between one and two is not ideal. Zero bars means that you need to run another device scan, the Envoy needs to be relocated, or that one or more electrical appliances are causing interference. Troubleshoot power line communication issues as follows.

Issue: The Microinverter Count is Lower than the Number of Installed Units

The microinverter count is an indication of the number of online microinverters producing power, reporting in to the Envoy, and not having any error conditions. If this number is lower than expected, it may indicate that the Envoy is not done scanning/discovering the entire array. Alternatively, it may indicate that the Envoy is having difficulty communicating over the power lines. It could also be a result of low light levels or that the PV module voltage is too low for the microinverter to power up. To troubleshoot the issue:

- Check the Inventory screen on the Envoy local interface to view any microinverters not reporting in to the Envoy or having any error conditions.
- Make sure that the Envoy is plugged directly into the wall and **not** into a power strip or surge protector.
- Relocate your Envoy as close to the AC mains as possible. This ensures that the Envoy receives the strongest possible signal from each microinverter.
- Unplug any other device that is sharing the outlet with the Envoy. Or, as an alternative, plug the Envoy into a circuit that supports fewer electronic appliances. Appliances sharing a receptacle with the Envoy may interfere with power line communication.
- If this problem occurs when light levels are low, try again during daylight hours.

Issue: Envoy Displays Fewer than Three Bars

Follow the previous procedure for “Issue: The Microinverter Count is Lower than the Number of Installed Units”.

Issue: Envoy Displays Zero Bars

The following conditions may exist.

Has a device scan been run while the array was active? The Envoy may have run a device scan on power-up when the array was not connected to the grid or when the array was not powered by sunlight.

- Run another scan during daylight hours.
- Check that the circuit breaker(s) for the PV array are in the “ON” position. For the Envoy to communicate with the microinverters, the PV circuit breakers must be in the “ON” position in the AC mains.
- Verify that the PV modules are connected to the microinverters.

Is the Envoy plugged into a good location? The Envoy needs to be plugged into an AC outlet near the primary AC mains or the array's downstream subpanel.

- Make sure the Envoy is not plugged into an outlet strip or surge protector.
- Plug the Envoy into an outlet closer to the AC mains or subpanel.
- Unplug other devices from the AC outlet used for the Envoy.
- As an alternative if signal strength is poor, power the Envoy from the solar production circuit (where local electrical code allows for monitoring equipment on the same circuit). This provides the best possible power line communications. The Envoy must be located indoors (a garage, attic, basement, or other cool, dry location) or in an outdoor weatherproof enclosure. Remember that the Envoy must also have Ethernet access via the broadband router, either directly with a CAT5 cable, Enphase wireless adapter, or via a power line communication bridge.

Is the system energised? PV modules power microinverters, PV modules provide power only during daylight hours, and microinverters communicate only when powered.

- Run another scan during daylight hours.
- Check that the circuit breaker(s) for the PV array are in the “ON” position. For the Envoy to communicate with the microinverters, the PV circuit breakers must be in the “ON” position in the electrical AC mains.
- Verify that the PV modules are connected to the microinverters.

Is there a phase imbalance?

- Ask the electrician to measure the conductors and neutral line to verify that the phases are balanced. If the phases are not balanced, electricians must recheck the wiring.

The Envoy is plugged into a circuit on the primary AC mains, but the PV circuit breakers are on a downstream subpanel: The primary AC mains is full and doesn't have additional capacity to add circuit breakers.

- Add a subpanel with a small subset of circuit breakers. In this case, it is best to add an additional 5-Amp circuit breaker and then run an outlet off that subpanel. Plug the Envoy into that AC outlet, so that it can be close to the PV circuit breaker.

Network Basics and Troubleshooting

To the Local Area Network (LAN), the Envoy is just another host on the network, much like a personal computer. Enphase offers technical support at <http://www.enphase.com/support> for Envoy issues, but Enphase's Support responsibility does not extend to the premises network or LAN.

The Envoy must obtain a DHCP (Dynamic Host Configuration Protocol) IP address and have a route to the Internet. The Envoy will request this IP address from the broadband router during the power-up sequence. Two small green LEDs on the Ethernet port indicate Internet link and activity. One LED will be solid green, and the other will blink every few seconds.

Issue: IP Address Problems

When the Envoy first boots up, it is configured to perform a DHCP broadcast, requesting an IP address from a DHCP source. This source can be a server/computer, but almost all consumer-grade broadband routers also provide DHCP services as well. This is the usual source of IP addresses for network hosts (computers, laptops, and the Envoy).

If the IP address displayed on the Envoy's LCD screen is 169.254.120.1, or if the IP address does not match the DHCP subnet on the internal network, then the Envoy was unsuccessful in obtaining a DHCP lease from the router.

- Check network connectivity to the router or other DHCP server. You may also wish to contact your Internet Service Provider or refer to your router documentation for help.
- Check that you are using a broadband router and not a switch or a hub. Many hubs and switches cannot provide a DHCP lease and may not allow the Envoy to connect to the web.
- Use the Envoy menu button to "Get New IP Address", and then allow 30 to 60 seconds for the new IP address to appear on the Envoy LCD screen.
- When using the Ethernet cable, two small LEDs on the Ethernet port indicate Internet link and activity. One LED will be solid green, and the other will blink green or yellow every few seconds. If the LEDs are not both on or blinking, try using a new Ethernet (CAT5) cable in place of the existing cable.
- Power down all units in the chain, applying power again in this order: 1) modem, 2) router, and 3) Envoy. Allow a few minutes for the IP address to be reassigned.
- Try another Ethernet cable (between Envoy and router).

Issue: LCD Screen Displays "-Web"

This means that the Envoy has no connection to the Enlighten website.

- Allow a few minutes longer. If the Envoy has recently received a valid IP address, it will likely display "+Web" momentarily.
- Check network connectivity to the router. You may also wish to contact your Internet Service Provider or refer to your router documentation for assistance.
- Unplug all units in the chain, applying power again in this order: 1) modem, 2) router, and 3) Envoy. Allow a few minutes for the IP address to be reassigned.
- Try another Ethernet cable (between Envoy and router).
- Access the Administration screen on the Envoy local interface as directed on page 39, and click "Update Interface 0".
- Temporarily remove any power line communication bridges, and connect the Envoy directly to the broadband router.
- Run the "Network Connectivity Check" on the Ethernet Network Configuration administrative page on the Envoy.

Issue: LCD Screen Displays "Envoy Failure" with "+Web" or "-Web"

This message displays after the Envoy has tried unsuccessfully three times to initialise.

- Unplug the Envoy from the AC outlet and plug it in once again. Leave it in place for at least 15 minutes.
- If it continues to display "Envoy Failure" or if it never moves beyond the Initialization stage, contact Enphase Customer Support at <http://www.enphase.com/support>.

Issue: LCD Screen Displays "Scanning Inhibited"

This message displays after an installer has used the Installer's Toolkit to provision the Envoy. Leave the Envoy in this condition for normal operation. If you need to re-enable scanning, contact Enphase Customer Support at <http://www.enphase.com/support>.

Issue: The Envoy has Good Signal Strength but is Too Far from the Router

You may need to use power line communication bridges, an Enphase wireless adapter, or a wireless Ethernet bridge.

Issue: Wireless Adapter Wi-Fi Problems

- If the wireless installation fails, try these solutions:
 - ✓ Verify that the Envoy is at version "R3.8" or later. If needed, upgrade the Envoy as directed.
 - ✓ Verify that the wireless adapter is fully inserted in the left Envoy USB port (looking at the Envoy from the front).
 - ✓ Power down all units in the chain, applying power again in this order: 1) modem, 2) router, and 3) Envoy.
- If the Envoy is installed in an enclosure and you are using the wireless adapter, that enclosure must be plastic or fiberglass to allow wireless communication. Metal enclosures impede wireless communication.
- Stucco and plaster wall construction may contain metal mesh, which can affect wireless range. If you cannot see your router or access point in the list on the Envoy, or cannot maintain a connection, relocate the Envoy to be closer to your router or access point.
- If you remove the wireless adapter, wait about 15 seconds before re-inserting it.

Issue: How Set Up Wi-Fi Without Wi-Fi WPS

Envoy with wireless adapter supports several wireless security protocols in addition to Wi-Fi WPS. These include WEP Open System, WEP Shared Key, WPA-PSK, WPA2-PSK, WPA-EAP, and WPA2-EAP. If your router does not support Wi-Fi WPS or you do not wish to use Wi-Fi WPS, you can follow these steps to establish a wireless connection using one of the listed protocols.

- a. Verify that the wireless adapter is fully seated in the left USB port (looking at Envoy from the front).
- b. Plug the included Ethernet cable either to a laptop directly or to a PC on the same broadband router network.
- c. Access the Envoy Administration page.
- d. Enter the default login credentials for the Administration menu:
 - Username: **admin**
 - Password: **admin**

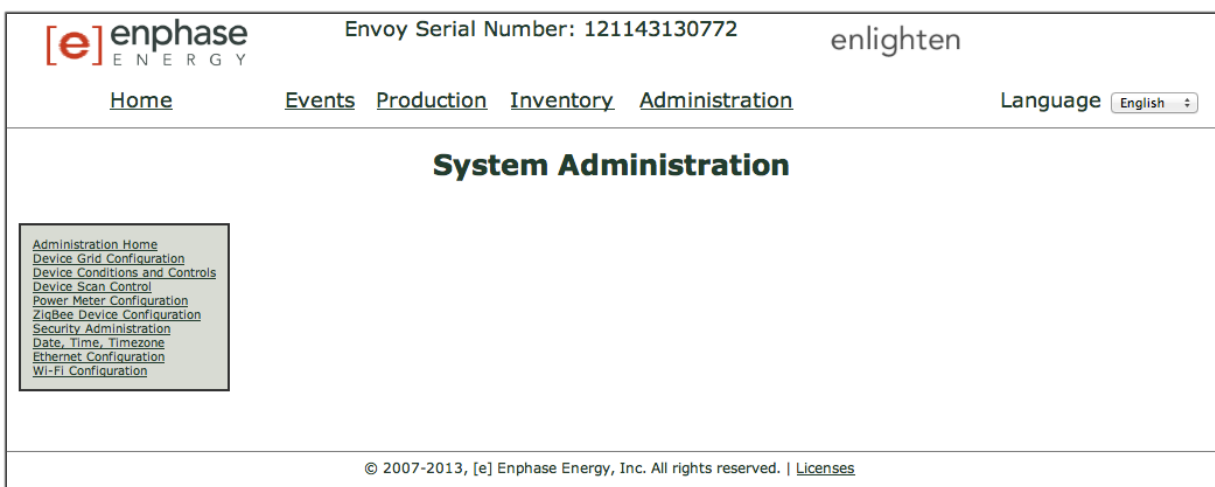

- e. From the Administration menu, select **Wi-Fi Configuration**. This menu option is available only when the wireless adapter is installed in a USB port on the Envoy.

- f. The interface displays a list of available networks.
- g. Click a network to select it, enter the password, and click **Test Connection**.

- If you don't see your network listed, the router SSID broadcast may be blocked. If so, enter the SSID (name) and password.
- If your network is not blocked and not listed, click **Re-Scan** to refresh the list of networks.
- Status messages appear during the connection process, including "Connection Test" and "Confirmation".

- h. Click **Join Network** when displayed.

- Once you have joined a network, it appears in bold in the list of available networks.

- i. Disconnect the Ethernet cable. Within two minutes, an updated IP address appears on the Envoy LCD screen. This IP address begins with a "W" to indicate that a wireless connection is established. Within a minute, the Envoy LCD screen displays **+Web**, indicating a successful connection to Enphase.

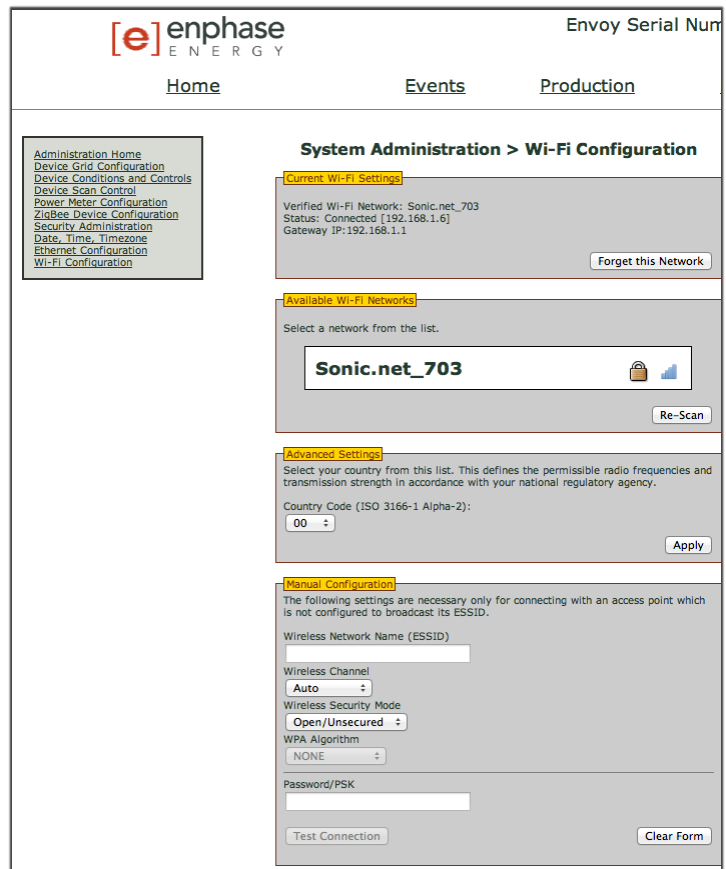

Issue: Internet Traffic is Slower After Installing a Bridge

A power line communication bridge can establish communication with a bridge in a neighbouring home or business. This condition is called bridge crosstalk and it can affect your volume of Internet traffic. To see if an Internet traffic slowdown problem is caused by crosstalk, disconnect the bridge from the router. If after that, the Envoy stays online and the bridge continues to indicate connectivity, you are probably getting connectivity from another bridge. Reconnect the bridge to the router and disconnect the other bridge from the Envoy. If after that, your volume of Internet traffic increases, other devices are probably getting access to the Internet through your bridge. Reconnect the bridge. To prevent this problem, use the solution below according to the type of bridge you have.

Asoka PL9650:

Change the password for your pair of bridges. Asoka has free Windows-only configuration software that allows password change for the PL9650 in the "Advanced" screen of their configuration utility. This operation requires an Ethernet cable and access to both ends of the bridge. The configuration software is available at <http://www.asokatech.com/downloads-page>.



Asoka PL9660-Q1:

1. Plug in both PlugLinkAV adapters.
2. From either PlugLinkAV adapter, Press the push button for one second, (no more than two seconds) then release. The Power LED light will start blinking. NOTE: You will have two minutes to get to the second PlugLinkAV adapter.
3. From the second PlugLinkAV adapter, press the push button for one second, then release. The Power LED light begins blinking. Allow about 15 seconds for the pairing to occur. If the pairing is successful, the Power LED light goes from blinking to solid.



Tenda P200:

1. Press the Pair button on Adapter 1 for two to three seconds and then release it. The Power LED on the Adapter 1 will start blinking.
2. Within two minutes upon releasing adapter 1's Pair button, press the Pair button on Adapter 2 for two to three seconds and then release it. The Power LED on the Adapter 2 will start blinking.
3. Observe the two adapters' LED status. If the Power and PLC LEDs on the two adapters light up solid, it indicates that an encrypted private Power line network has been successfully created.

**DHCP versus Static IP Addressing**

If the site owner prefers not to use DHCP, you can set up the Envoy to use a static IP address.

- Use the Envoy's web-interface to navigate to the ADMINISTRATION page. The Username is "admin", and password is "admin". Click the "Network Connectivity" menu item. This allows you to see if the Envoy is using DHCP or Static-IP, and it allows you to change this setting if needed.
- Click "Check Network Connectivity" to view the Envoy connections.



WARNING: Do not change the Envoy DHCP setting to use a static IP address unless you also reserve the same IP address on the broadband router. See the section on DHCP reservations in the router instructions. Failure to reserve the static IP address on the router will result in duplicate IP addresses and intermittent Internet connection problems with the Envoy.

MAC Filtering

Check to see if MAC filtering is in use at the site. This has nothing to do with Apple Macintosh computers, but rather, refers to the MAC (Media Access Control) address that each individual network card possesses. The MAC Address is a 48-bit address, which uniquely identifies that piece of hardware. MAC filtering is a security mechanism by which routers allow administrators to specify which devices can use the router for access to the Internet. This prevents unauthorised/unknown personnel from using the router to get to the Internet.

An example of a MAC address would be: 00:17:F2:D6:B1:45

MAC addresses contain six pairs of characters, including any number 0-9 and letters A-F.

The MAC address of the Envoy will begin with: 00:D0:69:41:

If MAC filtering is in use at the site, identify the specific MAC address of the Envoy and add it to list of authorised devices on the router. To do this, browse to the home page of the Envoy's web-service using an ordinary web-browser. The home page contains that specific Envoy unit's MAC address. The MAC address is also located on a sticker that is located on the back of the Envoy.

Firewall Settings

The Envoy initiates **outbound** connections to Internet servers. Such connections may be restricted by firewall rules set up on the site's broadband router. Broadband routers typically allow all outbound connections but restrict any/all inbound connections.

If outbound firewall rules are applied at the site, you must configure a static IP address for the Envoy and add new rules that allow outbound access as follows:

Direction	Source	Protocol	Port	Destination
OUT	<Envoy IP address>	TCP	80, 443	reports.enphaseenergy.com
OUT	<Envoy IP address>	TCP	443	home.enphaseenergy.com
OUT	<Envoy IP address>	UDP, TCP	80	ping.enphaseenergy.com
OUT	<Envoy IP address>	UDP	123	europe.pool.ntp.org

The Envoy connects to these servers using their DNS names. If you add firewall rules for Envoy reporting, Enphase recommends using the DNS names rather than the underlying IP addresses. This is because the IP addresses are subject to change without notice.

Replacing an Envoy

If problems remain after following the troubleshooting steps above, contact Enphase at <http://www.enphase.com/support>. If Customer Support authorises an Envoy replacement (RMA), perform the following steps.

1. Disconnect the Ethernet cable and power cord from the old Envoy.
2. When the replacement Envoy arrives, connect it to the Ethernet cable and power cord.
3. Verify that the new Envoy powers up. The Envoy LCD may display "**Upgrading... Do Not Unplug**" for up to 20 minutes. Wait for this to complete before proceeding.
4. Verify that the new Envoy indicates "**+Web**" within five minutes. If not, follow the network troubleshooting steps above.
5. If possible, log in to Enlighten and add the Envoy to the Activation for this system by clicking "**Add Another Envoy**" under the "**Envoy**" section.
6. Verify that the new Envoy start discovering microinverters within 20 minutes of starting up. If necessary, use the LCD menu (or the Enlighten Envoy page) to start a new device scan during daylight hours. (See Using the Envoy LCD Menu on page 20.)



NOTE: If the old Envoy has communicated to the microinverters on the same day that the new replacement Envoy is installed, the new Envoy will be unable to discover the microinverters. Contact Enphase at <http://www.enphase.com/support> for assistance in this situation.

7. After all microinverters have been discovered, stop the new device scan using the LCD menu. (See Using the Envoy LCD Menu on page 20.)
8. Assess the power line communications by running a Communication Check from the LCD menu (or from the Enlighten Envoy page) during daylight hours. (See Using the Envoy LCD Menu on page 20.) If fewer than three bars are shown, relocate the Envoy for better power line communications.
9. Contact Enphase Support at <http://www.enphase.com/support> to have the new Envoy added to your system and to retire the replaced Envoy.
10. Ship the old Envoy to Enphase using the supplied RMA shipping label.

Envoy Local Interface

The Envoy relays data to Enlighten, and connection to the Enphase Enlighten web-based monitoring and analysis software requires an Internet connection. However, if there is no broadband router at the installation site, you can communicate directly with the Envoy using the Ethernet port and a personal computer with a web browser.

Connecting to the Envoy through the Site's LAN

The following steps describe how to access the Envoy data through the site's LAN (local area network).

1. Open an Internet browser application on a computer connected to the same LAN as the Envoy.
2. In the browser address window, enter the IP address displayed in the LCD screen of the Envoy.

Once the browser has successfully connected with the Envoy, the home screen is displayed in the browser window.

Directly Connecting to the Envoy without a Broadband Router

The following steps describe how to access the Envoy data through the local connection in the absence of a broadband router.

1. Connect one end of the Ethernet cable supplied with the Envoy to the Ethernet port on the Envoy.
2. Connect the other end of the Ethernet cable to the Ethernet port of the computer.
3. Open an Internet browser application on the computer.
4. In the browser address window, enter the IP address displayed in the LCD screen of the Envoy.



NOTE: If you fail to make a connection at this point, you can manually configure your IP address to 169.254.120.2 and subnet mask to 255.255.0.0. If this does not correct the problem, contact Enphase Customer Support at <http://www.enphase.com/support>.

Once the browser has successfully connected with the Envoy, the home screen is displayed in the browser window.

Home Screen

The Home screen provides a system overview and shows the current status of the microinverters that have been identified by this Envoy. From this screen, you can access other screens in the interface.

Envoy Serial Number: 121145084498

enlighten

[Home](#)
[Events](#)
[Production](#)
[Inventory](#)
[Administration](#)

Language

System Overview

System Operation

Connection to Microinverters
 Connection to Web

System Statistics

Lifetime generation	6.61 kWh
Currently generating	1.20 kW
Last connection to website	0 minutes
Number of Microinverters	7
Number of Microinverters Online	7
Current Software Version	D3.6.19 (a49911)
Software Build Date	Wed May 08, 2013 06:47 PM PDT
Database Size	1132 kB (0 % full)
Current Timezone	US/Pacific

This screen includes information on web connection, microinverter count and various other data.



NOTE: In the System Statistics table, the “Number of Microinverters Online” may differ from the “Number of Microinverters” due to several factors including time lags, power line communication problems, and error conditions on the microinverters.

Events Screen

To view events for your system, click **Events** from the Envoy Home screen to navigate to the Events screen. This screen includes information on events occurring on connected Enphase devices.

Envoy Serial Number: 121145084498

enlighten

[Home](#)
[Events](#)
[Production](#)
[Inventory](#)
[Administration](#)

Language

Events

Show entries

Search:

Event Id	Event	HW Serial Num	Device	Date
886	DC Power Too Low: Clear	121145057873	pcu	Thu May 09, 2013 01:46 AM PDT
885	DC Power Too Low: Clear	121245017383	pcu	Thu May 09, 2013 01:46 AM PDT



37

© 2014 Enphase Energy Inc.

141-00014 Rev 04

Production Screen

To view system energy harvest statistics for your system, click **Production** from the Enphase home screen to navigate to the Production screen.

Enphase Serial Number: 121145084498



[Home](#)
[Events](#)
[Production](#)
[Inventory](#)
[Administration](#)
Language English

System Energy Production

System has been live since Wed May 08, 2013 09:34 PM PDT	
Currently	1.20 kW
Today	5.49 kWh
Past Week	6.85 kWh
Since Installation	6.91 kWh

Inventory Screen

To view a listing of the devices in your system, click **Inventory** from any screen to navigate to the Inventory screen.

Enphase Serial Number: 121145084498

[Home](#)
[Events](#)
[Production](#)
[Inventory](#)
[Administration](#)
Language English

System Inventory

New Device Scan Status
Scanning for new devices is **inactive**.

[Device Scan Control](#)

Microinverter

Show 25 entries Search: Search Reset Table

HW Part Num	Installed	HW Serial Num	Device Status	Running Image - Updated	Assembly Part Num	Controller Part Num	Last Report
800-00299-r02	Wed May 08, 2013 09:34 PM PDT	121245017383	OK	520-00044-r01-v01.15.04 - Tue May 07, 2013 09:36 PM PDT	880-00046-r02	480-00010-r01-v03.05.10	Thu May 09, 2013 10:01 AM PDT
800-00005-r07	Wed May 08, 2013 09:35 PM PDT	030823001974	OK	520-00001-r00-v00.04.20 - Tue May 07, 2013 09:55 PM PDT	fff-ffff-rff-vff.ff.ff	560-00001-r01-v03.03.09	Thu May 09, 2013 10:01 AM PDT
800-00103-r05	Wed May 08, 2013 09:38 PM PDT	121145057873	OK	520-00040-r01-v03.41.03 - Thu May 02, 2013 09:48 PM PDT	880-00008-r23	480-00009-r01-v02.02.13	Thu May 09, 2013 10:01 AM PDT

Administration Screen

The Administration screen of the Envoy local interface contains several configurable options. Click **Administration** to access this menu.



NOTE: For Envoy performance reasons, Enphase does not recommend giving the Envoy a publicly accessible IP address. However, if you must place the Envoy on a public-facing IP address, Enphase recommends that you change the Administration password to disallow unauthorised modification to your Envoy. **(This situation is rare, since consumer-grade routers normally provide the Envoy with an internal network IP address that is not publicly accessible.)**

For reference, your private/internal IP address space will be in the 192.168.x.x, 172.16(-31).x.x, 10.x.x.x or 169.254.x.x range. If you are unsure if your Envoy is on the public Internet, contact your network administrator or Internet Service Provider.

The default login credentials for the Administration menu are:

- Username: **admin**
- Password: **admin**

Administration Screen Tasks

The following sections describe several Administration Screen tasks. Perform these tasks only when needed. Administration tasks include:

- Set or Change the Grid Profile
- Set Up Device Scan Control
- Set Time Zone
- Other Administration Tasks

Set or Change the Grid Profile

Many Enphase Microinverters have field adjustable voltage and frequency trip points. Trip points are input voltage or frequency values that trigger the microinverters to shut down when the values are exceeded. If local regulations require adjustments to these trip points, or if the grid profile was not set up during registration (see page 11), the installer can set up the system to use an alternate Grid Profile (set of trip points).



IMPORTANT! The Envoy is required for each installation. It provides monitoring and allows you to configure the Grid Profile on the microinverters. You must configure the Grid Profile before the microinverters can export power.



NOTE: Only an authorised installer, following the requirements of the local regulatory authority, is allowed to make Grid Profile adjustments.



NOTE: Grid profile changes are applied only after a microinverter is detected.

Grid profile management tasks include:

- Set the grid profile for your region
- View or verify current trip point settings
- Generate a report for confirmation of site settings to the utility or other authority

To set a grid profile for the first time, you do not need a “change token”. However, to change a grid profile, you do need a “Change Token”. Change tokens are issued on a per Envoy serial number basis. This procedure includes instructions on how to get a Change Token. If needed, contact Enphase Customer Support at <http://www.enphase.com/support> for a Grid Profile Change Token as directed on the screen. Change tokens expire after a day, so later grid profile changes may require a new token.

1. From the System Overview screen, click on **Inventory** and verify that all installed microinverters are detected.
2. Click **Administration** to access the Administration menu.
The default log in credentials for the Administration menu are:
 - Username: **admin**
 - Password: **admin**

The System Administration screen appears.

Envoy Serial Number: 121219018468
enlighten

[Home](#)
[Events](#)
[Production](#)
[Inventory](#)
[Administration](#)

Language English

System Administration

[Administration Home](#)
[Device Grid Configuration](#)
[Device Conditions and Controls](#)
[Device Scan Control](#)
[Security Administration](#)
[Date, Time, Timezone](#)
[Ethernet Configuration](#)

© 2007-2013, [e] Enphase Energy, Inc. All rights reserved. | [Licenses](#)

3. From the Administration menu, select **Device Grid Configuration**.

If no alternate device grid configuration has been applied, the following Device Grid Configuration screen appears, which indicates that the microinverters require a grid profile. This screen allows a licensed solar professional to select and apply the appropriate trip points for the solar installation.

The screenshot shows the 'System Administration > Device Grid Configuration' page. At the top, it displays the Envoy Serial Number: 121219018468 and the enlighten logo. The navigation bar includes Home, Events, Production, Inventory, and Administration. A sidebar on the left lists various administration options. The main content area has three sections: 'Current Grid Configuration' with a warning 'The microinverters do not have a grid configuration', 'Select Grid Profile' with a warning 'These settings should only be adjusted by a licensed solar professional' and two dropdown menus for 'Country regulatory specification' and 'Grid profile', and 'Apply Grid Profile' with an 'Apply Grid Profile' button. Two orange callout boxes on the right point to the dropdown menus with the text 'Click here to select Country regulatory specification' and 'Click here to select Grid profile'.

If an alternate device grid profile has been applied, the following screen appears:

This screenshot is similar to the previous one but shows the 'Country regulatory specification' dropdown set to 'United Kingdom G83-1' and the 'Grid profile' dropdown set to 'UK G83-1 default'. Below these dropdowns is a table of parameters. An orange callout box on the right points to the 'Apply Grid Profile' button with the text 'Click here to Apply Grid Profile'.

Parameter	Value	Units
Voltage limits		
Over voltage limit	262.0	V
Over voltage trip time	1.5	s
Under voltage limit	209.0	V
Under voltage trip time	1.5	s
Frequency limits		
Over frequency limit	50.5	Hz
Over frequency trip time	0.5	s
Under frequency limit	47.0	Hz
Under frequency trip time	0.5	s

4. Select a **Country regulatory specification**.

5. Select a **Grid profile** appropriate for your region.

- If you are changing the grid profile continue with step 6.
- **If you are configuring the system with a grid profile for the first time, go to step 14.**

6. Make note of the Envoy serial number and the authorization number on the screen. You will need this information in the following steps.
7. Click the link to the Enlighten website. (If you do not already have an account, click **Enlighten Login** at the Enlighten website to register.) Note that this link will not appear if the Envoy shows “-Web” on the LCD screen.



NOTE: If the Envoy displays “-Web”, see “Network Basics and Troubleshooting” on page 30.

8. Once logged in at the Enlighten website, locate the Grid Profile Change Token widget. If you don't see this widget add it now:
 - Click **Add a widget**.
 - Select **Grid Profile Change Token**.
9. Enter the Envoy serial number.

10. Enter the authorization number from the Envoy Interface.

Copy this token.

11. Click **Get Token**.
12. Copy the token.
13. Paste or enter the token in the Grid Profile screen.

14. Click Apply Grid Profile.

This propagates the settings to the microinverters.

The Apply Profile screen appears. This screen shows the Grid Profile Status for each microinverter. Initially the status for each unit is shown as un-set, soon followed by a status of "propagating." After approximately 10 minutes, the status is "set."

Administration Home
Device Grid Configuration
Device Conditions and Controls
Device Scan Control
Security Administration
Date, Time, Timezone
Ethernet Configuration

Apply Grid Profile

Regulatory specification: United Kingdom G83-1
Profile: UK G83-1 default

Last grid profile status refresh: Thu May 23, 2013 11:27:46 AM PDT
This page will refresh every minute
[View Grid Profile Report](#)

Show 10 entries Search: Search Reset Table

HW Part Num	Installed	HW Serial Num	Grid Profile Status	Last Report
800-00090-r04	Thu May 23, 2013 11:11 AM PDT	121206041542	propagating	Thu May 23, 2013 11:27 AM PDT
800-00090-r04	Thu May 23, 2013 11:11 AM PDT	121206041890	propagating	Thu May 23, 2013 11:26 AM PDT
800-00090-r04	Thu May 23, 2013 11:15 AM PDT	121206041805	propagating	Thu May 23, 2013 11:27 AM PDT
800-00146-r01	Thu May 23, 2013 11:15 AM PDT	121310000021	propagating	Thu May 23, 2013 11:27 AM PDT

Showing 1 to 4 of 4 entries

© 2007-2013, [e] Enphase Energy, Inc. All rights reserved. | Licenses

This screen also allows you to generate a report to confirm that the microinverters have been set with an updated grid profile.

15. Click View Device Profile Report.

The Device Profile Report screen appears.

Administration Home
Device Grid Configuration
Device Conditions and Controls
Device Scan Control
Security Administration
Date, Time, Timezone
Ethernet Configuration

Device Profile Report

Envoy Serial Number: 121219018468
Current Grid Profile Status
Regulatory Specification: United Kingdom G83-1
Grid Profile: UK G83-1 default

Report generation time: Thu May 23, 2013 11:34 AM PDT
Enter site information below:

Site Name
123 Avenue
Town, State/Province
Country

HW Part Num	Grid Profile Status	Number of Microinverters
800-00090-r04	set	3
800-00146-r01	set	1

Grid Profile: UK G83-1 default

Parameter	Value	Units
Voltage limits		
Over voltage limit	262.0	V
Over voltage trip time	1.5	s
Under voltage limit	209.0	V
Under voltage trip time	1.5	s
Frequency limits		
Over frequency limit	50.5	Hz
Over frequency trip time	0.5	s
Under frequency limit	47.0	Hz
Under frequency trip time	0.5	s

© 2007-2013, [e] Enphase Energy, Inc. All rights reserved. | Licenses

16. Enter the site information in the window provided.

17. Use your browser to send this report to your printer or to save it to a file. After printing or saving the file, you can send it to the local regulatory agency to verify the trip point settings.

Set Up Device Scan Control

The “controlled” device scan differs from other Envoy device scans in that it allows control over the scan period, scanning method, and the number of devices. When first installed, the Envoy initiates an eight-hour scan. This initial scan is the only scan needed for most systems.



NOTE: At sites with more than 100 microinverters, Enphase recommends using a controlled device scan and specifying the total number of devices to be discovered. This speeds up the discovery process. See the following procedure for details.

Run a controlled scan only to detect new or previously undetected microinverters.

To run a controlled scan:

1. From the Administration menu, choose **Device Scan Control**. The Device Scan Control screen appears.
2. Enter a **Scan Duration** in days:hours:minutes (e.g., 0:00:60 to indicate zero days, zero hours, and 60 minutes). The scan duration depends on many factors, such as number of devices to be detected and quality of power line communication. You may want to start with a one-hour scan and increase the duration as needed.

3. Although optional, it is **best practice** to enter a value for **Total Devices**. Enter a value in this field. **The Envoy stops scanning once it has detected the given number of devices.**



NOTE: The Total Devices option can be used in conjunction with the Priority Duration option to help discover any last few microinverters.

4. Enter a **Priority Duration** (optional) in days:hours:minutes (e.g., 0:00:20 to indicate zero days, zero hours, and 20 minutes). If you enter a value in this field, the Envoy makes scanning the sole activity for the period specified.



NOTE: The Priority Duration option should only be used in limited situations, e.g., at large sites or sites experiencing problems discovering devices with the normal scan.

5. Click Start Scan to complete this task. The LCD screen displays the following, where “nnnn” represents the number of microinverters (devices) detected.

```
Priority Scan is
Active.  Devs: nnnn
```

Set the Time Zone (optional)

Ordinarily, the Envoy obtains the time zone setting from Enlighten. If you do not have an Internet connection for the Envoy, you may want to set the local time zone. **This step is not necessary if the Envoy is reporting to Enlighten.** To set the time zone:

1. From the Administration menu, choose **Date, Time, Time Zone**.
2. Under **Time Zone Setting**, select a time zone from the **Select Time Zone** drop down menu.
3. Click **Update timezone setting** to complete this task.

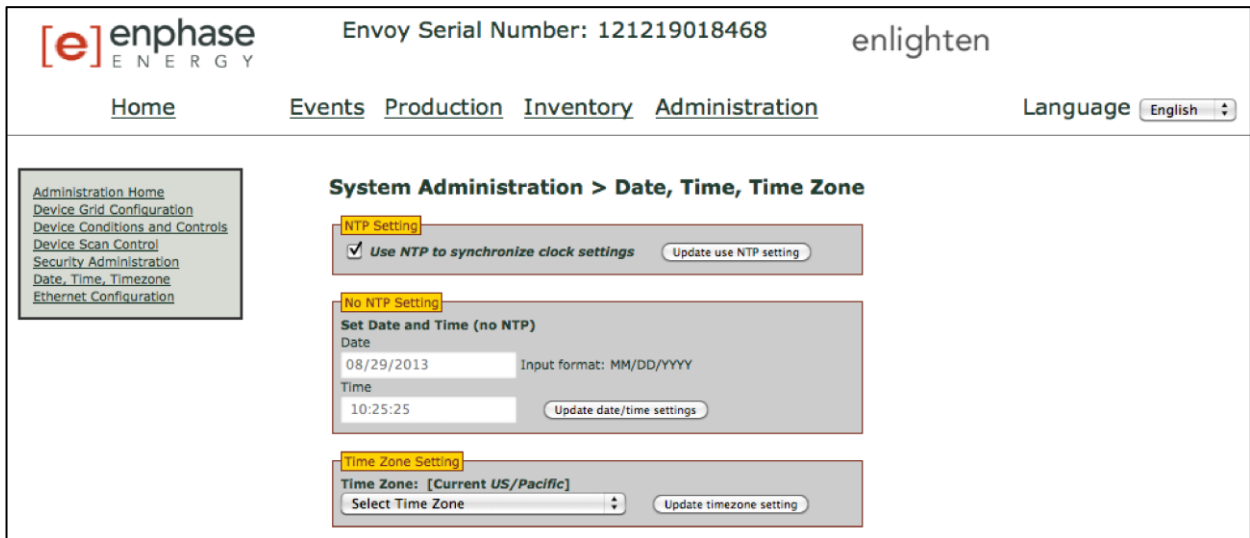

Other Administration Tasks

Other Administration menu options not described in this manual are not required for normal system operation and should only be performed when recommended by Enphase.

Event Messages

The following table lists messages that the Envoy local interface displays to indicate various conditions. These messages appear on the computer screen when your computer is connected to the Envoy local interface.

Message Shown on Events and Inventory Screens	Description
AC Frequency Changing Too Fast	<p>Recommended Action: No action is required unless the condition persists.</p> <p>Description: AC frequency is the frequency at which voltage varies on the electricity network. The microinverter reports that this value is changing more rapidly than allowed. Frequency Changing Too Fast events are usually transient and self-correcting by the electricity network.</p>
AC Frequency Out Of Range	<p>Recommended Action: This condition should correct itself. No action is required.</p> <p>Description: The microinverter reports that the frequency coming from the electricity network is either too low or too high as specified by applicable regional standards.</p> <p>AC frequency is the frequency at which voltage varies on the electricity network. Frequency Out of Range events are usually transient and self-correcting by the electricity network.</p> <p>When the microinverter detects an out of frequency condition, it must remain offline until the electricity network has been within acceptable limits continuously for a short period of time (seconds to minutes, varies by region). If, during that time, the utility again exceeds or falls short of acceptable limits, the timer must restart and the microinverter may not begin producing power for an additional short period following the last out-of-bounds condition.</p> <p>If the condition persists: Contact your installer or refer to the Troubleshooting Guide at http://www.enphase.com/support.</p>
ACMonitorError	<p>Recommended Action: No action is required unless the condition persists.</p> <p>Description: The microinverter is temporarily unable perform power conversion.</p> <p>If the condition repeats or persists: Contact your installer to arrange for the installation of a replacement microinverter.</p>
AC Voltage Average High	<p>Recommended Action: No action is required unless the condition persists.</p> <p>Description: The microinverter reports that the average AC voltage coming from the utility over the past 10 minutes was too high for the configured grid profile.</p> <p>If the condition persists: Contact your installer or refer to the Troubleshooting Guide at http://www.enphase.com/support.</p>
AC Voltage Out Of Range	<p>Recommended Action: This condition should correct itself. No action is required.</p> <p>Description: The microinverter reports that the AC voltage coming from the utility is either too low or too high as specified by applicable regional standards.</p> <p>When a microinverter detects the voltage out of range condition, it does not produce power (per regulation) until the utility voltage returns within acceptable limits for several minutes (time varies by region). If during that time the utility voltage again goes beyond acceptable limits, the timer restarts.</p> <p>If the condition persists: Contact your installer or refer to the Troubleshooting Guide at http://www.enphase.com/support.</p>

Message Shown on Events and Inventory Screens	Description
Applying grid profile xx from regulatory specification yy	<p>Description: The Envoy has started a change to the grid profile for the microinverters. This process may take a few minutes. No action is required.</p> <p>xx = grid profile name yy = Regional specification name.</p>
Bad Flash Image	<p>Description: The microinverter is not producing power due to a software problem.</p> <p>Recommended Action: Contact Enphase Energy customer support.</p>
Commanded Reset	<p>Recommended Action: No action is required; it will automatically resume normal operation momentarily.</p> <p>Description: The microinverter was reset, either following a successful software download or by user command.</p>
Control Request	<p>Recommended Action: No action is required.</p> <p>Description: The Envoy has received a control request made via the Envoy interface (Administration > Device Conditions and Controls page) or via Enlighten. This uncommon condition will occur only during isolated troubleshooting procedures by Enphase personnel.</p>
Critical Temperature	<p>Recommended Action: This condition should correct itself. No action is required.</p> <p>Description: This rare condition occurs if the microinverter reports an internal temperature that exceeds its rated range. It reacts by producing less power to reduce internal temperature. This reflects internal temperature coming from a sensor inside the microinverter, not the ambient temperature. Once the internal temperature of the microinverter is once again within normal limits, it will resume full power production and this event message will clear.</p> <p>If the condition persists: Contact your installer or Enphase Energy customer support at http://www.enphase.com/support.</p>
DC Power Too Low	<p>Recommended Action: This condition should correct itself. No action is required.</p> <p>Description: This condition may occur at sunrise or sunset, while the modules are covered with snow, or during very bad weather. This event indicates that sunlight levels are too low for effective production. Once sunlight levels increase, the microinverter resumes power production and this event message will clear.</p> <p>If the condition persists: Contact your installer or Enphase Energy customer support at support@enphase.com.</p>
DC Resistance Low	<p>Recommended Action: No action is required unless the condition persists.</p> <p>Description: An insulation resistance (IR) sensor in the microinverter measures the resistance between the positive and negative PV inputs to ground. If either resistance drops below a threshold, the microinverter raises this condition. This may indicate defective module insulation, defective wiring or connectors, moisture ingress, etc.</p> <p>If the condition persists: Contact your installer or refer to the Troubleshooting Guide at http://www.enphase.com/support.</p>

Message Shown on Events and Inventory Screens	Description
DC Voltage Too High	<p>Recommended Action: Ask your installer to check that the PV module and microinverter are compatible. It may be that the PV module generates a higher voltage than is recommended for the microinverter. The Enphase M250 and M215 are compatible with most 60-cell modules.</p> <p>Description: The microinverter reports that DC input voltage from the PV module is too high.</p> <p>If the condition persists: If the PV module is compatible and the condition persists, contact your installer or refer to the Troubleshooting Guide at http://www.enphase.com/support.</p>
DC Voltage Too Low	<p>Recommended Action: This is usually a normal condition during hours of low light and at dawn and dusk.</p> <p>Description: The microinverter reports that DC input voltage from the PV module is too low. If this condition does not clear during hours of full daylight, the microinverters may be heavily shaded or covered by snow.</p> <p>If the condition persists: If this event occurs during full daylight or if the condition persists, contact your installer or refer to the Troubleshooting Guide at http://www.enphase.com/support.</p> <p>If this event occurs and clears daily or often during hours of full daylight, check that the PV module and microinverter are compatible. The M215 and M250 are compatible with most 60-cell modules.</p>
Download to module begun	<p>Description: The Envoy has started a software upgrade to the indicated microinverter.</p> <p>Recommended Action: This process may take a few minutes. No action is required.</p>
Download to module ended	<p>Description: The Envoy has successfully delivered a software upgrade to a microinverter.</p> <p>Recommended Action: No action is required.</p>
Download to module failed	<p>Description: The Envoy was unable to successfully deliver a software upgrade to a microinverter.</p> <p>Recommended Action: No action is required; the Envoy will repeat the attempt.</p>
Envoy Failure	<p>Recommended Action: Unplug the Envoy from the AC outlet and plug it in once again. Leave it plugged in and in place for at least 15 minutes.</p> <p>Description: This message displays after the Envoy has tried unsuccessfully three times to start up.</p> <p>This condition does not affect your system's ability to produce power. When the connection is restored, the Envoy will catch up with the transmission of any/all energy data it has stored.</p> <p>If the condition persists: If the Envoy continues to display Gateway (or Envoy) Failure or if it never moves beyond the Initialization stage, contact your installer or refer to the Troubleshooting Guide at http://www.enphase.com/support.</p>
Filesystem integrity audit failed	<p>Description: The Envoy file system integrity audit has failed.</p> <p>Recommended Action: For assistance, contact Enphase Energy customer support at http://www.enphase.com/support.</p>

Message Shown on Events and Inventory Screens	Description
Grid Profile Incompatible	<p>Recommended Action: The microinverters may need to have a software upgrade in order to be compatible with the selected grid profile. (The selected grid profile defines operating parameters that are compatible with your utility service.) If a microinverter software upgrade does not start automatically a few minutes after the after Envoy has discovered all microinverters, contact Enphase Energy customer support. Note that the Envoy requires a minimum of 3 bars to communicate effectively with the microinverters for the software upgrade.</p> <p>Description: This message displays when the selected grid profile is incompatible with microinverter software or hardware. This condition can affect your system's ability to produce power.</p> <p>If the condition persists: Contact Enphase Energy customer support at http://www.enphase.com/support.</p>
Grid Gone	<p>Recommended Action: In most cases no action is required. This occurs if there is a power outage in your area and the system has stopped production. Solar production will resume when the utility restores power to your area. Verify that the circuit breaker(s) for the PV array are ON at the AC mains. If all breaker(s) are on, the condition should clear itself.</p> <p>Description: The microinverter has detected grid instability. In most cases, this points to a problem with the utility service (e.g., a power outage). In other cases, this may be a false positive and a microinverter may be incorrectly reporting grid instability. In this case a microinverter software upgrade may be needed to help resolve this issue.</p> <p>If the condition persists: If Grid Gone events persist, contact your installer or refer to the Troubleshooting Guide at http://www.enphase.com/support.</p>
Grid Instability	<p>Description: The microinverter is not producing power due to one or more of these conditions: AC Frequency Out Of Range, AC Voltage Out Of Range, or Grid Gone. Note that Grid Instability will remain for about five minutes after the underlying conditions clear. No power is produced during this time.</p> <p>Recommended Action: No action is required unless the condition persists. If it persists, contact Enphase Energy customer support.</p>
Grid Offset Hi	<p>Recommended Action: No action is required unless the condition persists.</p> <p>Description: The average current to the grid is too high for the configured grid profile.</p> <p>When the microinverter is operating normally, no DC current is injected into the grid. If the DC current is too high, this may indicate an issue with the microinverter.</p> <p>If the condition persists: Contact your installer or refer to the Troubleshooting Guide at http://www.enphase.com/support.</p>
Grid Offset Low	<p>Recommended Action: No action is required unless the condition persists.</p> <p>Description: The average current to the grid is too low for the configured grid profile.</p> <p>When the microinverter is operating normally, no DC current is injected into the grid. If the DC current is too low (negative), this may indicate an issue with the microinverter.</p> <p>If the condition persists: Contact your installer or refer to the Troubleshooting Guide at http://www.enphase.com/support.</p>
Grid profile application completed	<p>Description: The Envoy has completed a change to the grid profile for the microinverters. No action is required.</p>
HardwareError	<p>Recommended Action: Contact your installer to arrange for the installation of a replacement microinverter.</p> <p>Description: A hardware failure has occurred that prevents power conversion.</p>

Message Shown on Events and Inventory Screens	Description
Module added	<p>Description: The Envoy has detected and is now associated to a new microinverter.</p> <p>No action is required.</p>
Microinverter failed to report	<p>Recommended Action: Ignore occasional instances of this event. Communication usually recovers on the next reporting cycle.</p> <p>If communications do not recover immediately, ensure that the Envoy is plugged in very near the AC mains. Also, if other devices are sharing the outlet with the Envoy, remove those devices from the outlet to improve signal strength.</p> <p>If the Enphase Envoy was recently relocated or if new devices or appliances were added to the circuit, it is possible that the new situation is not suitable for power line communication. The Envoy may need to be relocated to improve signal strength and reduce interfering noise on the power lines.</p> <p>To determine the quality of the Envoy's location for communication, run a Communications check by holding down the Envoy's menu button until the LCD display reads "Enable Communication Check" and then release the menu button. The Envoy will then broadcast a signal to the microinverters. Within 5 minutes, a "Communication Level" indication of 0 to 5 bars will display on the Envoy LCD display. The Envoy requires a minimum of 3 bars to communicate effectively with the microinverters.</p> <p>Description: The Envoy reporting this condition is unable to communicate with the microinverters over the power lines.</p> <p>If the condition persists: See "Power Line Communication Troubleshooting" on page 29, or contact your installer, or refer to the Troubleshooting Guide at http://www.enphase.com/support.</p>
Microinverter grid configuration failed after 5 attempts, retrying	<p>Description: The attempt to change the grid profile for the microinverters has failed after five tries. The Envoy will continue to attempt to change the grid profile.</p> <p>Recommended Action: No action is required.</p>
Microinverter grid configuration failure cleared after xx attempts	<p>Description: A failed attempt to change the grid profile for the microinverters has cleared. The grid profile was successfully applied.</p> <p>xx = number of attempts</p> <p>Recommended Action: No action is required.</p>
Module Sleeping	<p>Description: The microinverter is off for the night.</p> <p>Recommended Action: No action is required.</p>
No Grid Profile	<p>Recommended Action: Ask the installer to use the Envoy Gateway interface to select a grid profile for this system. For more information, see "Change or View the Grid Profile" on page 40</p> <p>Description: The Envoy has not been set up with a grid profile for the microinverters.</p>
Over Temperature	<p>Description: The microinverter is too hot and is not producing power. This very rare condition usually clears without intervention.</p> <p>Recommended Action: No action is required unless the condition persists. If it persists, contact Enphase Energy customer support.</p>
Power generation off by command	<p>Description: The microinverter is not producing power by user command. This uncommon condition will occur only during isolated troubleshooting procedures by Enphase personnel.</p> <p>Recommended Action: No action is required.</p>

Message Shown on Events and Inventory Screens	Description
Power On Reset	<p>Description: The microinverter has powered on after having DC disconnected.</p> <p>Recommended Action: No action is required.</p>
Shutdown	<p>Description: The Envoy has been powered down (unplugged from AC power).</p> <p>Recommended Action: Restore AC power to the Envoy.</p>
Startup	<p>Description: The Envoy has been powered back up (plugged back in to AC power).</p> <p>Recommended Action: No action is required.</p>
Transient Grid Profile	<p>Recommended Action: No action is required. This condition will clear once the grid profile test is complete.</p> <p>Description: This system is currently in test mode.</p>

Technical Data

Communications Interface	
Power line	Enphase proprietary
Ethernet	10/100 auto-sensing, auto-negotiation
USB (two ports)	USB 2.0 interface, auto-sensing, auto-negotiation
Capacity	
Monitoring capacity	Model number (SKU) ENV-230 monitors up to 600 Enphase Microinverters.
LAN Connection Options	
Cable assembly, Ethernet, RJ45, orange, 3m	Included with all models
Power line communication bridge pair	Order EPLC-02 (EU), EPLC-03 (UK) or EPLC-04 (AU) separately
Wireless N USB adapter (802.11b/g/n)	Order WF-01 separately
Power Requirements	
AC outlet	230VAC, 50Hz
Power consumption	2.5 watts typical, 7 watts maximum
Mechanical Data	
Dimensions (WxHxD)	222.5 mm x 112mm x 43.2mm
Weight	340g
Ambient temperature range	-40°C to +65°C
Cooling	Natural convection – no fans
Enclosure environmental rating	Indoor
Features	
Standard warranty term	2 years
Compliance	EN 60950-1, EN 55022 Class B, EN 55024, EN 50065-1, EN 50065-2-2, EN 61000-3-2, EN 61000-3-3
Meter accuracy	Envoy metering is qualified as +/- 5% or better.
API	Production data