

## TROUBLESHOOTING

### a LED overview

LED	State	Description
All	Flashing red in unison	The IQ Gateway Metered is booting up
	Flashing green sequentially	Software upgrade in progress
Network communications	Solid green	Communicating with Enphase Installer App
	Flashing green	WPS connection in progress or the IQ Gateway Metered is attempting to connect to Enphase Installer App
	Solid red	Local network connection only
	Off	No network connection
AP mode	Solid green	AP mode enabled: IQ Gateway Metered Wi-Fi network available
	Off	AP mode disabled: IQ Gateway Metered Wi-Fi network unavailable
Power production	Solid green	All communicating microinverters are producing
	Flashing green	Microinverter upgrade in progress
	Solid red	At least one microinverter is not producing
	Off	Microinverters are not producing or communicating (low light or night time)
Device communications	Solid green	All devices are communicating
	Flashing green	Device scan in progress
	Solid red	At least one device is not communicating
	Off	Devices are not communicating (low-light or nighttime)

### b Device detection issues

If the Device Communications LED  lights solid red, it may result from low-light levels. If there is insufficient sunlight to power up the microinverters, they cannot communicate with the IQ Gateway.

If there is sufficient daylight for the microinverters to power up, the issue may be that the IQ Gateway Metered is having difficulty in communicating over the power lines. To troubleshoot this issue:

- Check the Enphase Installer App to see which devices are not communicating.
- Check that the PV array's circuit breaker(s) are in the "ON" position.
- Verify that the PV modules are connected to the microinverters.
- Verify that the PV module DC voltage is within the allowable range for the microinverter.

### c Power production issues

If the Power Production LED  lights solid red, check the Enphase Installer App to see which microinverters are not producing power.

- If none of the microinverters are producing power, there may be a grid or wiring issue. First, verify the proper input voltage and frequency from the grid. Next, check the breaker and wiring, starting at the switchboard.
- If all of the non-productive microinverters are on the same branch, check the breaker and wiring starting at the junction box for the affected branch.
- If only one or scattered microinverters are not producing power, check to see that the AC connectors are fully seated in the engage cable connectors. Next, check that each module provides the required startup voltage for the microinverter (22 V). A PV module that is failing or that is undersized may not generate enough power for AC conversion.

### d Internet connection issues

If you are using Wi-Fi and the Network Communications LED  remains off:

- The WPS connection window may have timed out. Retry the connection steps.
- Ensure the broadband router is operational by checking that other devices at the site can access the network.
- Be aware that metal enclosures or obstructions impede wireless communication.
- If you cannot see your router or access point in the list on the IQ Gateway, or cannot maintain a connection, it may be necessary to add a wireless repeater to extend the network range.

If you are using Wi-Fi and the Network Communications LED lights solid red, ensure the broadband router is connected to the Internet by checking that other devices at the site can access the Internet.



If you are using the Enphase Mobile Connect modem and the Network Communications LED remains off or lights solid red, see Troubleshooting in the [Enphase Mobile Connect Installation Guide](#).

For any connection method, you can troubleshoot network issues with the Enphase Installer App by tapping the "Network" button, then "Diagnostic Tools".











If you replace the broadband router, configure the IQ Gateway Metered Wi-Fi settings for the new Wireless Network Name (SSID) and password.

## SAFETY

### Safety and advisory symbols

	<b>DANGER:</b> This indicates a hazardous situation, which if not avoided, will result in death or serious injury.
	<b>WARNING:</b> This indicates a situation where failure to follow instructions may be a safety hazard or cause equipment malfunction. Use extreme caution and follow instructions carefully.
	<b>NOTE:</b> This indicates information particularly important for optimal system operation. Follow instructions carefully.

### Safety instructions

	<b>DANGER:</b> Risk of electric shock. Risk of fire. Do not attempt to repair the IQ Gateway Metered; it contains no user-serviceable parts. Tampering with or opening the IQ Gateway Metered will void the warranty. Warranty void if cover removed. If the IQ Gateway Metered fails, contact Enphase customer support for assistance <a href="http://enphase.com/philippines">http://enphase.com/philippines</a> .
	<b>DANGER:</b> Risk of electrocution! Do not install CTs when current is flowing in the sensed circuit. Always install CT wires in the terminal blocks before energising the sensed circuit.
	<b>DANGER:</b> Risk of electric shock. Do not use Enphase equipment in a manner not specified by the manufacturer. Doing so may cause death or injury to persons, or damage to equipment.
	<b>DANGER:</b> Risk of electric shock. Be aware that installation of this equipment includes risk of electric shock. If you wire the IQ Gateway Metered at the sub-board, always de-energise the sub-board before beginning.
	<b>DANGER:</b> Risk of electric shock. Risk of fire. Only qualified personnel should troubleshoot, install, or replace the IQ Gateway Metered.
	<b>DANGER:</b> Risk of electric shock. Risk of fire. Do not wire unused terminals or terminal blocks on the IQ Gateway Metered.
	<b>WARNING:</b> Before installing or using the IQ Gateway Metered, read all instructions and cautionary markings in the technical description and on the IQ Gateway Metered.
	<b>WARNING:</b> Risk of equipment damage. If installing the IQ Gateway Metered in an enclosure, choose an area for installation where the ambient temperature does not exceed 46°C.
	<b>NOTE:</b> Do not install the CTs in a panel where they exceed 75% of the wiring space of any cross-sectional area within the panel, or refer to local standards for guidance.
	<b>NOTE:</b> Perform all electrical installations by all national and local electrical codes.
	<b>NOTE:</b> To ensure optimal reliability and to meet warranty requirements, the IQ Gateway Metered must be installed according to the instructions in this guide.

© 2023 Enphase Energy. All rights reserved. Enphase, the e and CC logos, IQ, and certain other marks listed at <https://enphase.com/trademark-usage-guidelines> are trademarks of Enphase Energy, Inc. in the US and other countries. Data subject to change. Rev04/2023-08-25

# Installing the IQ Gateway Metered

To install the IQ Gateway Metered, read and follow all warnings and instructions in this guide. Safety warnings are listed at the end of this guide.

### How it works

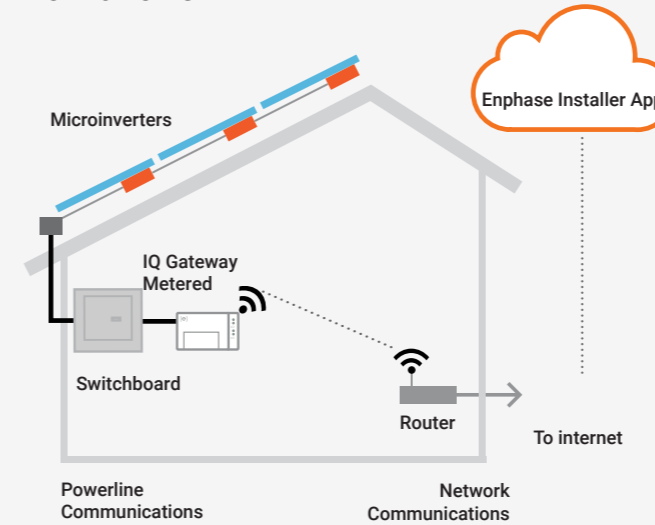



### IQ Gateway Metered display and controls

Track system installation progress with the Enphase Installer App mobile app. The LEDs on the IQ Gateway Metered are solid green when a function is enabled or performing as expected, flashing when an operation is in progress, or solid red when troubleshooting with Enphase Installer App is required. For a legend of all LED states, see [Troubleshooting a](#).

 **Network communications LED**  
Green when IQ Gateway Metered is connected to Enphase Installer App.

 **AP mode LED**  
Green when IQ Gateway AP Wi-Fi network is available.

 **AP mode button**  
Press to enable IQ Gateway AP mode for connecting with a mobile device. Hold for 5-seconds to start WPS connection to a router.

 **Power production LED**  
Green when microinverters are producing power.

 **Device communications LED**  
Green when devices are communicating with IQ Gateway Metered.

 **Device scan button**  
Press to start/stop 15minute scan for devices over the power line.

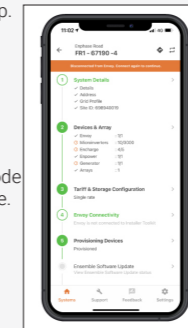

### PREPARATION

- Download the latest version of the Enphase Installer App and open it to log in to your Enphase Installer App account. This mobile app lets you connect to the IQ Gateway Metered to track system installation progress. To download, go to [enphase.com/installerapp](http://enphase.com/installerapp) or scan the QR code on the right.
- Check the box for the following items:
  - IQ Gateway Metered
  - Two split-core Current Transformers (CTs) for production and consumption metering
  - DIN rail for mounting the IQ Gateway Metered
  - Quick Install Guide (this document)
  - Anatel logo and warning labels
- Make sure there is enough space in the switchboard to install CTs. Do not install the CTs in a panel where they exceed 75% of the wiring space of any cross-sectional area within the panel.
- Install the IQ Gateway Metered in an IP54-rated or better enclosure with conduit attachment when installing outdoors. Do not drill holes on the top of the enclosure or anywhere that allows moisture ingress. Metallic enclosures may impair Wi-Fi signal strength. Use an appropriately rated enclosure if installing the IQ Gateway Metered indoors.
- If you are installing the IQ Gateway Metered in a multi-phase application, make sure you have the following items:
  - Additional CTs (CT-100-SPLIT) for multi-phase installations. Ensure you have one CT for each phase monitored for both production and consumption.
  - A phase coupler. If installing on a three-phase site, install a phase coupler on the load side of the overcurrent protection device. See your region's technical brief on phase coupling at [enphase.com/support](http://enphase.com/support). Consult Enphase support for compatible devices.
- Decide how to connect the IQ Gateway Metered to the Internet: choose Wi-Fi, an Enphase Mobile Connect modem, or Ethernet.
- Ensure to have the following optional items, if needed:
  - Enphase Mobile Connect™ modem (order CELLMODEM-02)
  - Ethernet over power line communication (PLC) bridge with Ethernet cables [order EPLC-02 (EU), EPLC-03 (UK) or EPLC-04 (AU/NZ)]
  - Ethernet cable [802.3, Cat5E or Cat6, unshielded twisted pair (UTP)]. Do not use shielded twisted pair (STP) cable.
- Install the PV system as directed by the installation manuals.
- If an Enphase PV system is or will be installed at the site, create a paper installation map to record device serial numbers and positions in the array. You will scan this map later using Enphase Installer App and your mobile device.
  - Peel the removable label from the bottom of the IQ Gateway Metered, and affix it to the paper installation map.
  - Always keep a copy of the installation map for your records.
  - For installation in Brazil, apply the Anatel logo label and warning label on to the IQ Gateway surface at a visible location. These labels are provided with this box.

**NOTE:** If needed, you can find an installation map with any [Enphase Microinverter Quick Install Guide](#).

For three-phase systems, use an external disconnect device for managing loss of phase (LOP) requirements.

## INSTALLATION

### 1 Choose a location for the IQ Gateway Metered

- Install the IQ Gateway Metered near the switchboard and consider the length of the CT leads (4 meters) when choosing the location.
- Install the IQ Gateway Metered in a protected dry space. If outdoors, install the IQ Gateway Metered in an IP54-rated, or better, enclosure with conduit attachment. Use an appropriately rated enclosure if hard wiring the IQ Gateway Metered indoors.  
**NOTE:** Metallic enclosures may impair Wi-Fi signal strength.
- Mount the IQ Gateway Metered horizontally using the included DIN rail.

### 2 Wire the IQ Gateway Metered for power and metering

For this step, refer to the wiring instruction sheet for your region.

### 3 Energize the IQ Gateway Metered

- Close the terminal block door, and secure it with the screw.
- Turn on the circuit feeding the IQ Gateway Metered.
- All four LEDs flash red during boot-up (approximately 2 minutes). When boot-up is complete, the Device Communications LED  lights solid red, indicating that devices are not yet detected.

### 4 Launch Enphase Installer App and start the system activation

- Launch Enphase Installer App. To create an activation for a new system, tap the plus button on the bottom right corner of the screen.
- Tap "System Details" to enter the required information.
- Complete the system activation in the Enphase Installer App by filling in the details.

The "System created successfully" message will display at the bottom of your screen, and system details will now appear as complete.

### 5 Adding devices and array to the system

This step is used to enter the unique serial numbers of all on-site devices. You should enter the serial number by scanning the barcode/QR code.

- Tap "Devices and Array" on the home page.
- Add the total number of devices to be installed in your system.
- Scan device serial numbers through bar code or QR code in respective device sections

In addition to using your device's camera to scan serial numbers, you can enter the serial numbers manually. Manual entry should be used only when you cannot scan any device's bar code or QR code.

- After scanning microinverters, you can use Array Builder to assign your scanned microinverters to an array or build an array manually.

This step can be completed post-commissioning as well.

### 6 Setting the tariff details (optional)

This step is used to enter the electricity rate structure of the utility.

- Tap "Tariff & Storage Configuration" on the home page.
- Subsequently, tap the "Tariff Editor" to enter the electricity import or export rate. Ensure the device is connected to the internet to complete this step.

### 7 IQ Gateway connectivity

This step is used to establish/monitor IQ Gateway connectivity to the Enphase Cloud and Enphase Installer App. You can also update IQ Gateway in this step if it is needed for successful commissioning.

- Tap the "IQ Gateway Connectivity" on the installer home page.

- If the "IQ Gateway" and the "Enphase Installer App" (or the phone icon) are not connected, perform the following steps:
  - On the IQ Gateway, press the AP mode button (first button from the left) for about one second. The LED will light solid green.
  - Go to your phone's settings and connect to IQ Gateway's Wi-Fi network.
  - Return to the Enphase Installer App "IQ Gateway Connectivity" page and connect.
- If the "IQ Gateway" and "Enphase Cloud (or the cloud icon)" are not connected, perform the following steps:
  - The IQ Gateway can connect to the Enphase Cloud through either Wi-Fi, Ethernet, or Cellular.
  - If Wi-Fi is selected, input the username and password for the Home/Office Wi-Fi.
  - If connecting using Ethernet, plug the cable into the IQ Gateway.

### 8 Provisioning the devices

To provision your devices, the Enphase Installer App should be connected to IQ Gateway via AP mode, as described in IQ the Gateway Connectivity section.

- If a green checkmark displays between the IQ Gateway and Enphase Installer App, tap "START PROVISIONING DEVICES". The "Provisioning Devices" screen displays the steps executed by the Enphase Installer App. The Enphase Installer App verifies and updates the grid profile in IQ Gateway and provisions all the connected devices.
- When provisioning is complete, tap "DONE".

### 9 Verify meter configuration

The production meter can be configured as per the following steps:

- Tap the "Meter Configuration" to start configuring the consumption and production meter.
- Subsequently, tap "Production Meter" to start configuring production meters. A pop-up notification appears asking to follow the meter wizard to verify your CT configuration. Select "Yes" to proceed.
- Tap "Enable production meter" to finish configuration of the production meter.

The consumption meter can be configured as per the following steps:

- Tap on "Meter Configuration" to start configuring consumption and production meter.
- Subsequently, tap on the "Consumption Meter" to start configuring production meters. A pop-up notification asks you to follow the meter wizard to verify your CT configuration. Select "Yes" to proceed.
- Tap "Enable consumption meter" to finish the configuration of the consumption meter.

### 10 Send summary report and complete homeowner walkthrough

This step is used to enter the unique serial numbers of all on-site devices. It is recommended that you enter the serial number by scanning the barcode/QR code.

- Tap "Summary" on the Enphase Installer App home page. The system report is displayed on the screen, which consists of a list of devices, their serial numbers, their last reports, and information about the grid profile applied to the devices.
- Tap "SHARE" in the right top corner to share the report as needed.
- Open the Homeowner Walkthrough and discuss all listed points with the homeowner. You can also show the homeowner the videos embedded in the links for a better experience.

## ACTIVATE MONITORING

Register the IQ Gateway Metered in Enphase Installer App (<https://enlighten.enphaseenergy.com/>).

### Method A // If the IQ Gateway Metered is associated with a system in Enphase Installer App

- On your mobile device, go to Settings and disconnect from the IQ Gateway's Wi-Fi network.
- Return to the Enphase Installer App app and tap the "Sync" button on the System Overview screen.
- When you have access to a computer with Internet access, log in to Enphase Installer App and select the system name from the Activation List on the dashboard.
- From the activation form, open Array Builder.

If you used Enphase Installer App to build arrays and scan device serial numbers, the array(s) are built—make any necessary adjustments in Array Builder.

If you did NOT use Enphase Installer App to build arrays and scan microinverter serial numbers, create the virtual array in Array Builder using the installation map as your reference. (You may need to wait if the devices have not yet reported to Enphase Installer App.)

### Method B // If the IQ Gateway Metered is not associated with a system in Enphase Installer App

- Log in to Enphase Installer App and click "Add a New System" from the dashboard.
- Enter the System, Installer, Owner, and Location information.
- Enter the IQ Gateway Metered serial number.
- Click "Save" to submit the form.
- After the devices have reported to Enphase Installer App, open Array Builder from the activation form, and create the virtual array, using the installation map as your reference.

## WIRING INSTRUCTION SHEET FOR SINGLE PHASE SYSTEM

The IQ Gateway Metered uses terminal blocks for power and metering connections. Wire these terminal blocks as described in the following.

You will need to install one split-core CT per monitored phase for production metering and one split-core CT per monitored phase for consumption metering. Use a protected route in conduit (raceway) for the CT wires to the IQ Gateway Metered.



**DANGER!** Risk of electric shock. Always de-energise circuits before wiring for power and CTs.

**DANGER!** Risk of electrocution! Do not install CTs when current is flowing in the sensed circuit. Always install CT wires in the terminal blocks before energising the sensed circuit.

- Before running the CT wires through conduit, use coloured tape to mark each of the CTs and the free ends of its wires, marking each with a different colour. You can run multiple CT wires through a single conduit.
- Wire the IQ Gateway Metered for power
  - Depending on the number of phases you will wire, use a 1-pole, 2-pole, and 3-pole (20 A maximum)circuit breaker for the supply wiring.
  - Make sure supply wiring is 2.5 mm<sup>2</sup> copper rated at 75°C or better.
  - Locate the screw on the terminal block door, and loosen it with a screwdriver to unlock the door and flip it open.
  - Connect Line 1 to L1, Line 2 to L2, Line 3 to L3, and Neutral to N, as required.
  - Tighten all connections to 0.56 N m.
- Install the Production CTs on phases as required:
  - Locate the arrow on the CT label.
  - To monitor production on Line 1:**
    - Connect the white wire to the "I1" terminal and the blue wire to the "I1" terminal.
    - Clamp the CT on active Line 1 of the solar production circuit with the arrow pointing toward the load (away from the solar array).
    - Tighten all connections to 0.56 N m.

**NOTE:** Because of variance in switchboard design and main power feed, there may not always be enough space to install CTs.

**NOTE:** It is important to match CT and voltage sense phases. Be sure to consistently identify all the AC lines at three points: the main switchboard feed, the IQ Gateway, and the solar production circuit breaker. Wire colours may not always consistently identify Lines 1, 2 and 3. If in doubt, use a multimeter to check.

- Install the Consumption CTs on phases as required:
  - Locate the arrow on the CT label.
  - Make sure that the AC mains wire(s) are de-energised until you have secured the CT wires in the terminal blocks.  
**Note:** Only run active conductors of the same phase through each CT. Each CT can monitor multiple active conductors.
  - To monitor consumption on Line 1:**
    - For the first CT, connect the white wire to "I1" and the blue wire to "I1".
    - Clamp the CT on the main supply Line 1 (active). When the Consumption CT is on Line 1 (active) conductor, the arrow must point towards the load (away from the grid).
    - Tighten all connections to 0.56 N m.

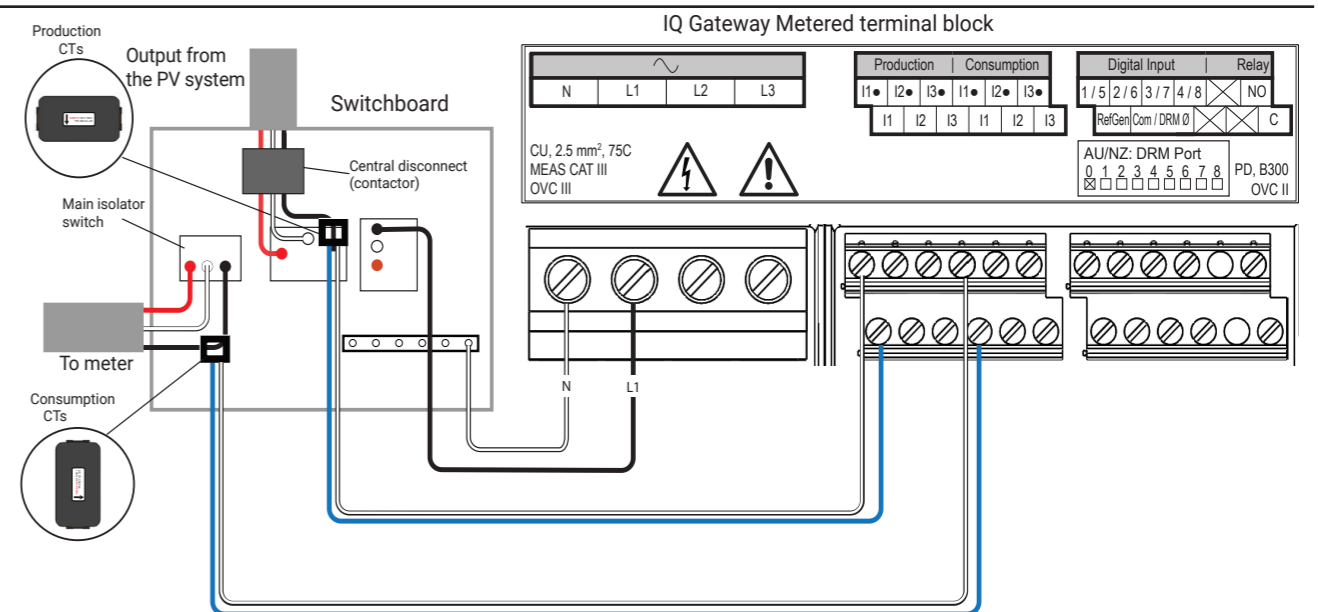

## WIRING INSTRUCTION SHEET FOR THREE PHASE SYSTEMS

The IQ Gateway Metered uses terminal blocks for power and metering connections. Wire these terminal blocks as described in the following.

You will need to install one split-core CT per monitored phase for production metering and one split-core CT per monitored phase for consumption metering. Use a protected route in conduit (wireway) for the CT wires to the IQ Gateway Metered.



**DANGER!** Risk of electric shock. Always de-energise circuits before wiring for power and CTs.

**DANGER!** Risk of electrocution! Do not install CTs when current is flowing in the sensed circuit. Always install CT wires in the terminal blocks before energising the sensed circuit.

- A) Before running the CT wires through conduit, use coloured tape to mark each of the CTs and the free ends of its wires, marking each with a different colour. You can run multiple CT wires through a single conduit.
- B) Wire the IQ Gateway Metered for power
- Depending on the number of phases you will wire, use a 1-pole, 2-pole, and 3-pole (20 A maximum) circuit breaker for the supply wiring.
  - Make sure supply wiring is 2.5 mm<sup>2</sup> copper rated at 75°C or better.
  - Locate the screw on the terminal block door, and loosen it with a screwdriver to unlock the door and flip it open.
  - Connect Line 1 to L1, Line 2 to L2, Line 3 to L3, and Neutral to N, as required.
  - Tighten all connections to 0.56 N m.
- C) Install the Production CTs on phases as required:
- Locate the arrow on the CT label.
  - To monitor production on Line 1:**
    - Connect the white wire to the "I1•" terminal and the blue wire to the "I1" terminal.
    - Clamp the CT on active Line 1 of the solar production circuit with the arrow pointing toward the load (away from the solar array).
  - To monitor production on Line 2:**
    - Connect the white wire to the "I2•" terminal and the blue wire to the "I2" terminal.
    - Clamp the CT on active Line 2 of the solar production circuit with the arrow pointing towards the load (away from the solar array).
  - To monitor production on Line 3:**
    - Connect the white wire to the "I3•" terminal and the blue wire to the "I3" terminal.
    - Clamp the CT on active Line 3 of the solar production circuit with the arrow pointing towards the load (away from the solar array).

**NOTE:** Because of variance in switchboard design and main power feed, there may not always be enough space to install CTs.

**NOTE:** It is important to match CT and voltage sense phases. Be sure to consistently identify all the AC lines at three points: the main switchboard feed, the IQ Gateway, and the solar production circuit breaker. Wire colours may not always consistently identify Lines 1, 2 and 3. If in doubt, use a multimeter to check.

- Tighten all connections to 0.56 N m.
- D) Install the Consumption CTs on phases as required:
- Locate the arrow on the CT label.
  - Make sure that the AC mains wire(s) are de-energised until you have secured the CT wires in the terminal blocks.
- Note:** Only run active conductors of the same phase through each CT. Each CT can monitor multiple active conductors.
- To monitor consumption on Line 1:**
    - For the first CT, connect the white wire to "I1•" and the blue wire to "I1".
    - Clamp the CT on the main supply Line 1 (active). When the consumption CT is on Line 1 (active) conductor, the arrow must point towards the load (away from the grid).
  - To monitor consumption on Line 2:**
    - For the second CT, connect the white wire to "I2•" and the blue wire to "I2".
    - Clamp the CT on the main supply Line 2 (active). When the consumption CT is on Line 2 (active) conductor, the arrow must point towards the load (away from the grid).
  - To monitor consumption on Line 3:**
    - For the third CT, connect the white wire to "I3•" and the blue wire to "I3".
    - Clamp the CT on the main supply Line 3 (active). When the consumption CT is on Line 3 (active) conductor, the arrow must point towards the load (away from the grid).
  - Tighten all connections to 0.56 N m.
- E) Install DRM support and a central disconnect as required for Australia. The multi-phase IQ Gateway Metered gateway supports demand response management (DRM). The IQ Gateway (ENV-S-WM-230 ) has a pre-installed 15 kΩ resistor that provides DRED bypass when DRED is not required.
- NOTE:** In systems where a central disconnect (contactor) is installed, you must configure the meters as described in Step 6 before device discovery can complete.

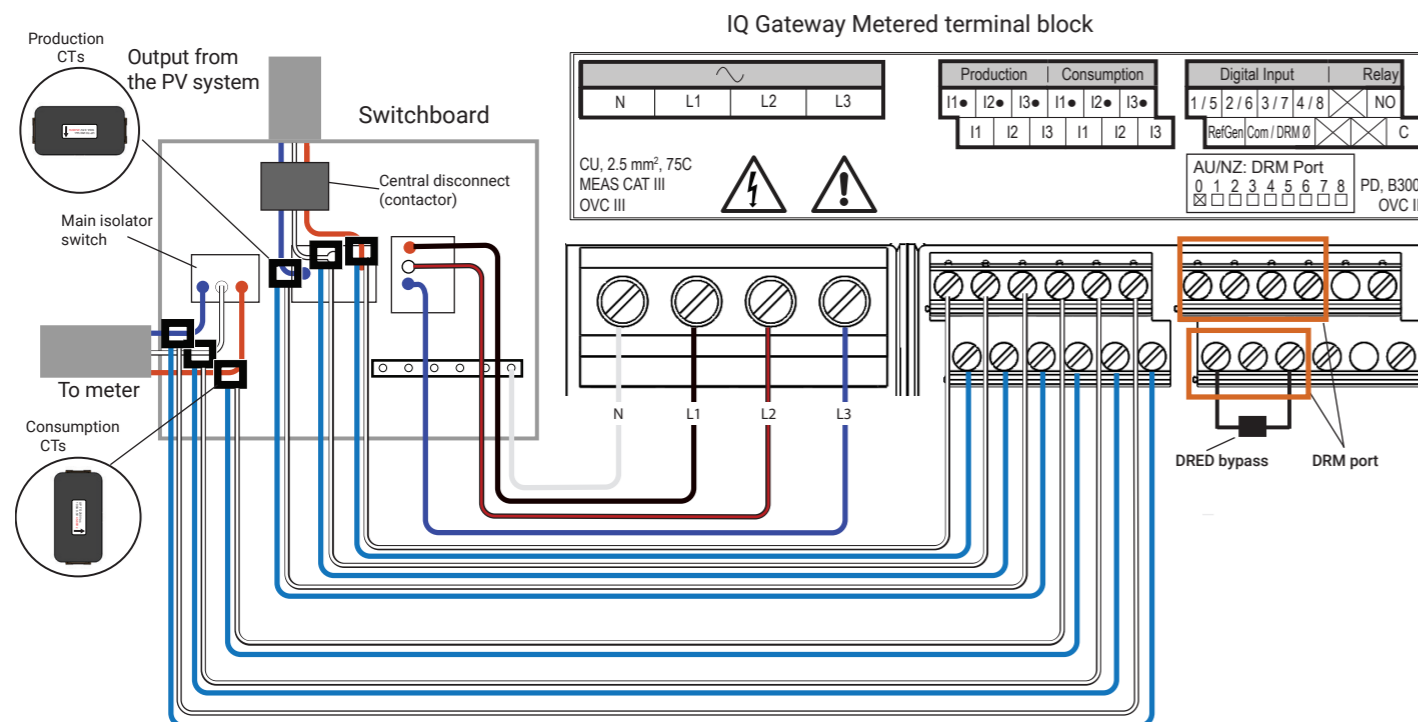

## Revision history

REVISION	DATE	DESCRIPTION
140-00194-04	August 2023	Updated the document for product names and editorial changes.
Previous releases		